

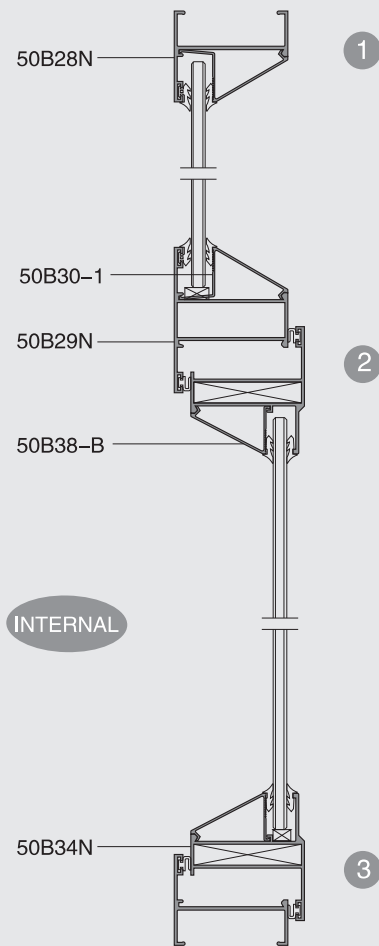

50B System out-opening Casement Window

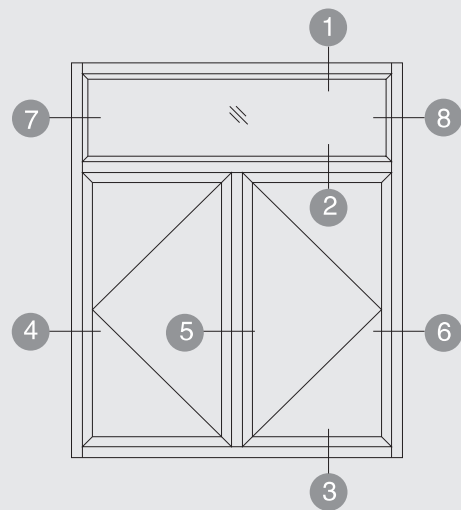

INTERNAL

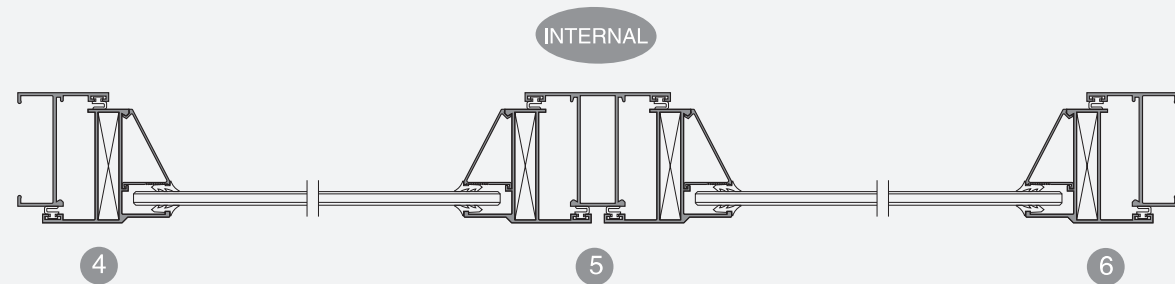
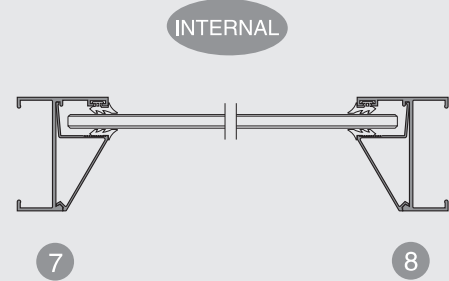

50B System in-opening Casement Window

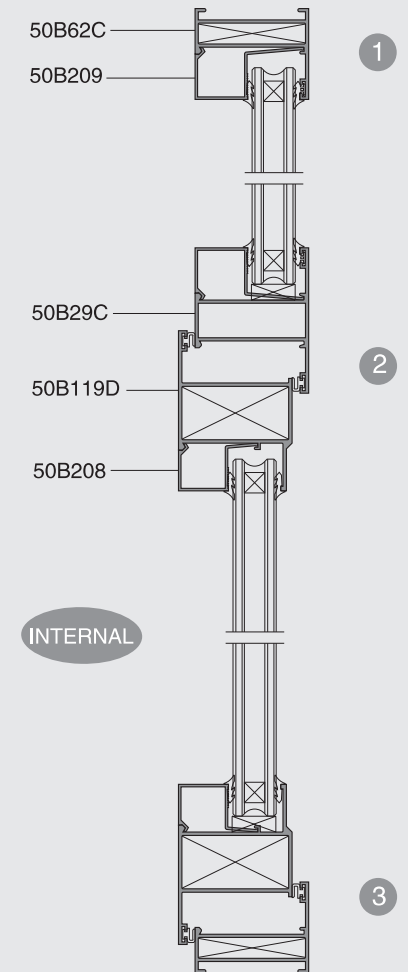
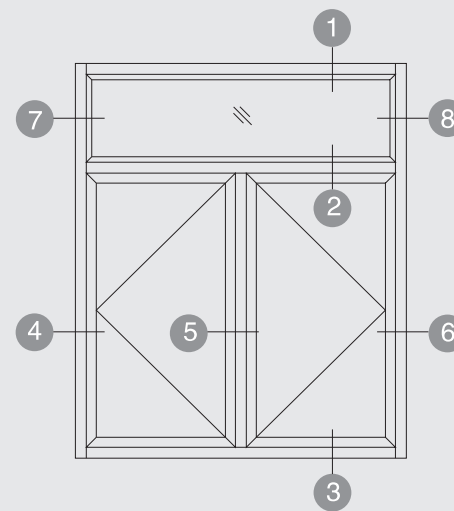

INTERNAL

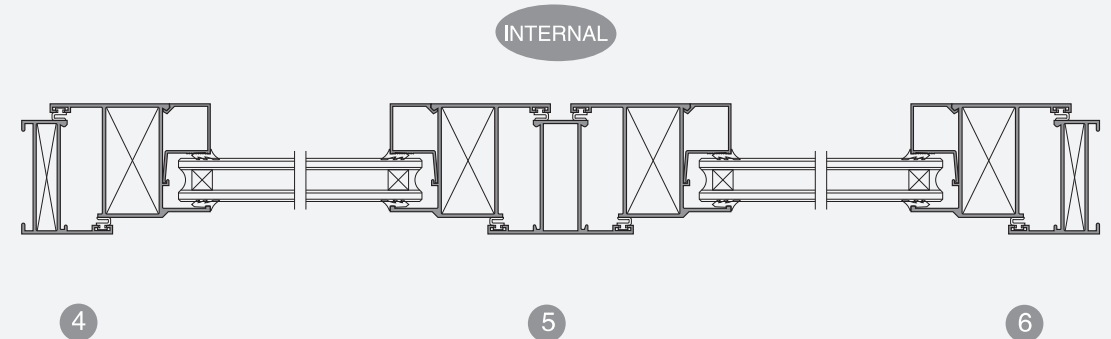
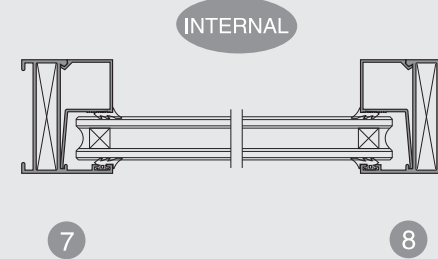



50B System in-opening Casement Window

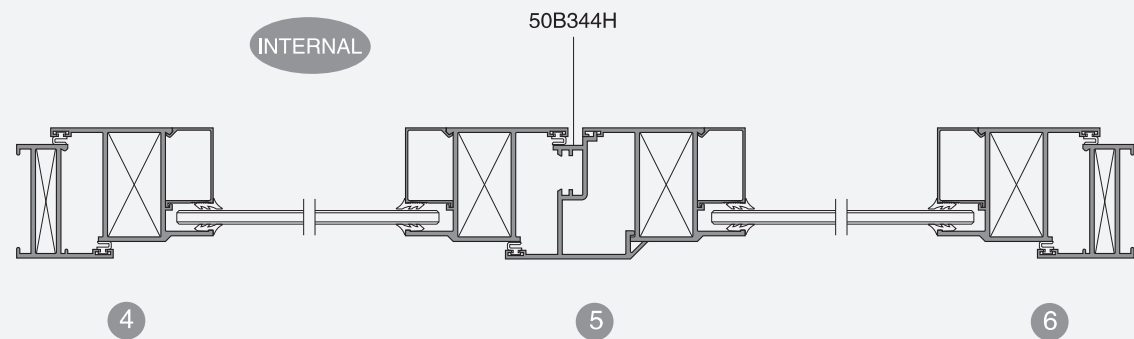
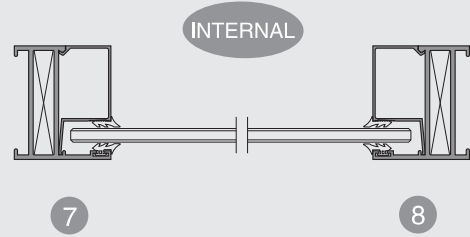
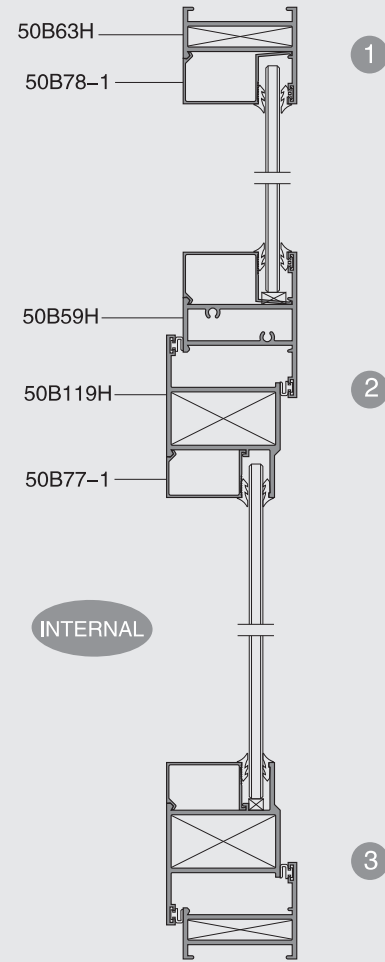
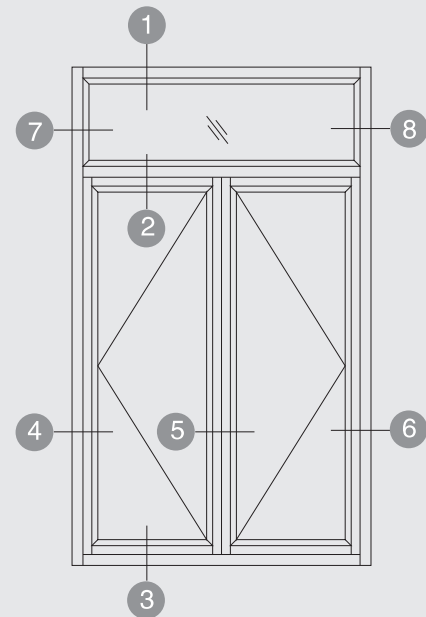

50B System out-opening Casement Door

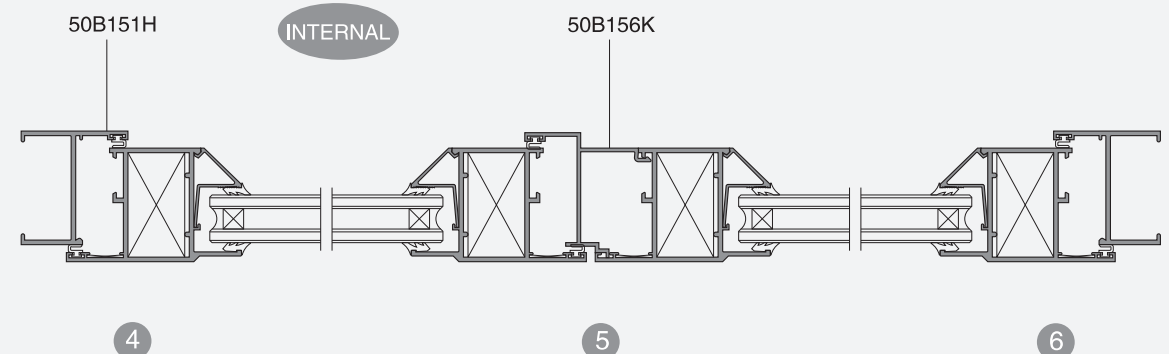
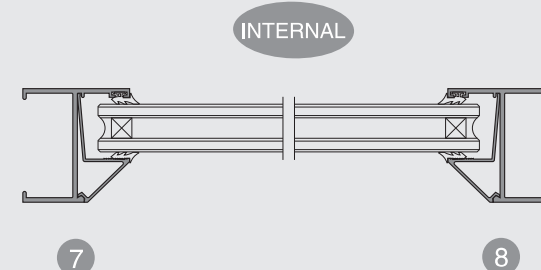
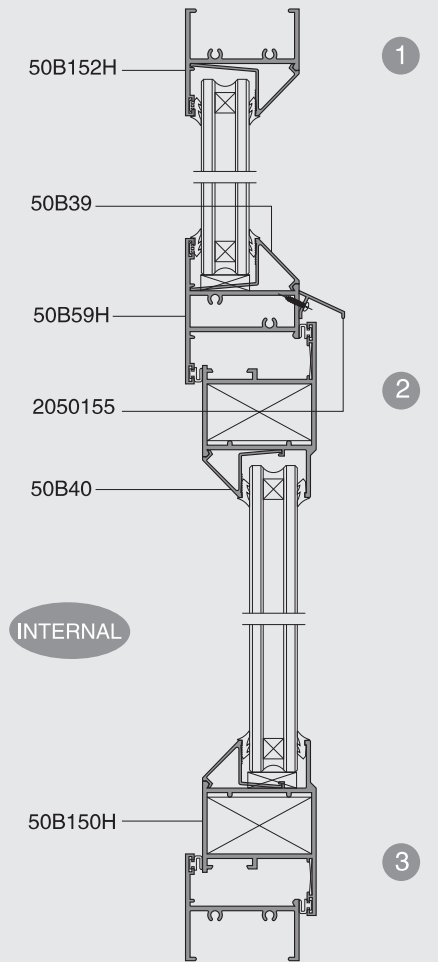
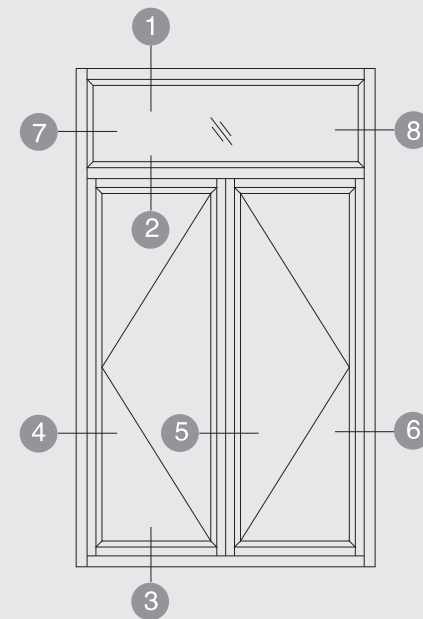



Application	Frame	Application	Frame	Application	Frame	Application	Frame
DWG No.	50B205	DWG No.	50B205C-A	DWG No.	50B28S	DWG No.	50B28N
Thickness	$\delta = 1.2$	Thickness	$\delta = 1.4$	Thickness	$\delta = 1.2$	Thickness	$\delta = 1.3$
T.W.	0.350kg/m	T.W.	0.411kg/m	T.W.	0.424kg/m	T.W.	0.476kg/m

1

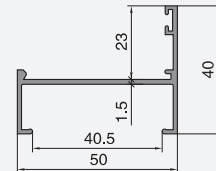
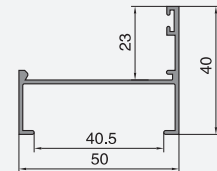
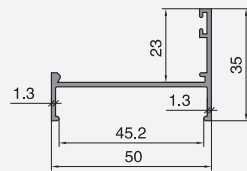
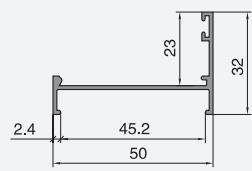

Application	Frame	Application	Frame	Application	Frame	Application	Frame
DWG No.	50B28N-A	DWG No.	50B28N-B	DWG No.	50B28C	DWG No.	50B28
Thickness	$\delta = 1.3$	Thickness	$\delta = 1.3$	Thickness	$\delta = 1.4$	Thickness	$\delta = 1.5$
T.W.	0.442kg/m	T.W.	0.450kg/m	T.W.	0.475kg/m	T.W.	0.538kg/m

2

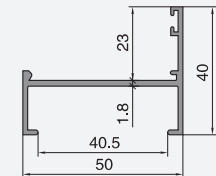
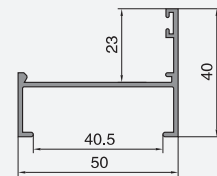
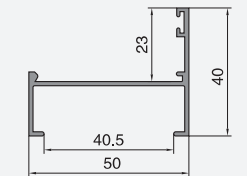
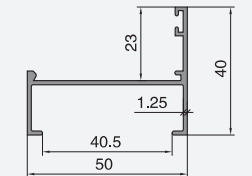

Application	Frame	Application	Frame	Application	Frame	Application	Frame
DWG No.	50B281	DWG No.	50B76N	DWG No.	50B76C	DWG No.	50B76D
Thickness	$\delta = 1.3$	Thickness	$\delta = 1.3$	Thickness	$\delta = 1.4$	Thickness	$\delta = 1.5$
T.W.	0.442kg/m	T.W.	0.499kg/m	T.W.	0.530kg/m	T.W.	0.595kg/m

3

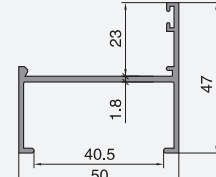
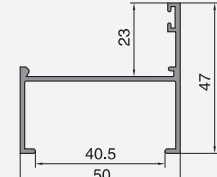
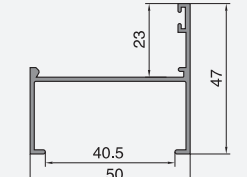
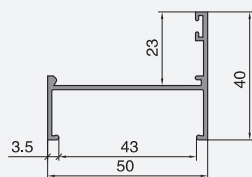

Application	Frame	Application	Frame	Application	Frame	Application	Frame
DWG No.	50B53N	DWG No.	50B53C	DWG No.	50B53D	DWG No.	50B100S
Thickness	$\delta = 1.3$	Thickness	$\delta = 1.4$	Thickness	$\delta = 1.5$	Thickness	$\delta = 1.4$
T.W.	0.518kg/m	T.W.	0.546kg/m	T.W.	0.607kg/m	T.W.	0.553kg/m

4

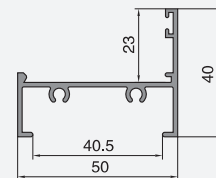
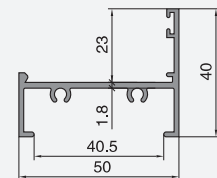
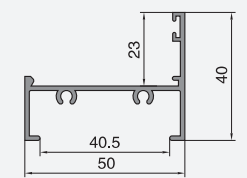
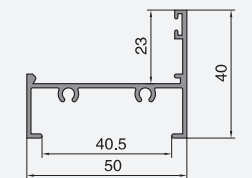

Application	Frame	Application	Frame	Application	Frame	Application	Frame
DWG No.	50B62C	DWG No.	50B45	DWG No.	50B63C	DWG No.	50B63K
Thickness	$\delta = 1.4$	Thickness	$\delta = 2.0$	Thickness	$\delta = 1.4$	Thickness	$\delta = 1.6$
T.W.	0.654kg/m	T.W.	0.828kg/m	T.W.	0.673kg/m	T.W.	0.746kg/m

5

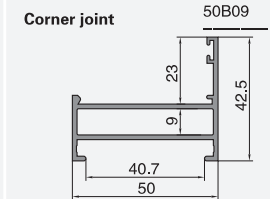
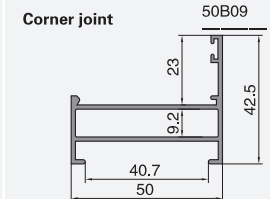
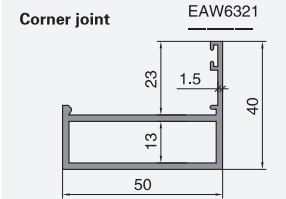
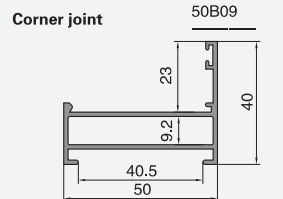

Application	Frame	Application	Frame	Application	Frame	Application	Frame
DWG No.	50B75C	DWG No.	50B75D	DWG No.	50B163C	DWG No.	50B127C
Thickness	$\delta = 1.4$	Thickness	$\delta = 1.5$	Thickness	$\delta = 1.4$	Thickness	$\delta = 1.4$
T.W.	0.558kg/m	T.W.	0.628kg/m	T.W.	0.513kg/m	T.W.	0.540kg/m

1

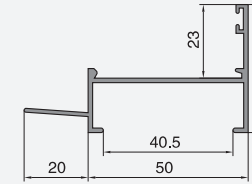
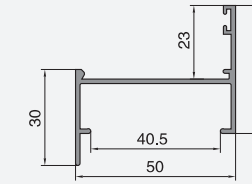
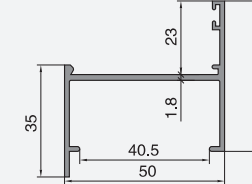
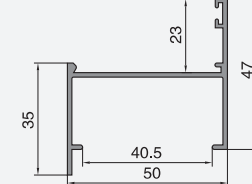

Application	Frame	Application	Frame	Application	Frame	Application	Frame
DWG No.	50B121N	DWG No.	50B107D	DWG No.	50B196B	DWG No.	50B171D
Thickness	$\delta = 1.3$	Thickness	$\delta = 1.5$	Thickness	$\delta = 1.1$	Thickness	$\delta = 1.5$
T.W.	0.553kg/m	T.W.	0.558kg/m	T.W.	0.483kg/m	T.W.	0.743kg/m

2

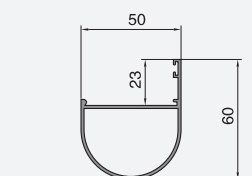
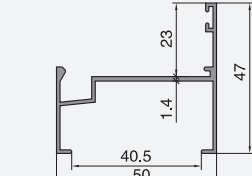
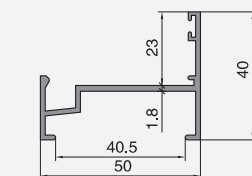
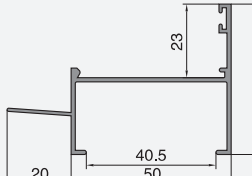

Application	Frame	Application	Frame	Application	Frame	Application	Frame
DWG No.	50B347C	DWG No.	50B376C	DWG No.	50B330C	DWG No.	50B329H
Thickness	$\delta = 1.4$	Thickness	$\delta = 1.4$	Thickness	$\delta = 1.4$	Thickness	$\delta = 2.0$
T.W.	0.550kg/m	T.W.	0.620kg/m	T.W.	0.562kg/m	T.W.	0.800kg/m

3

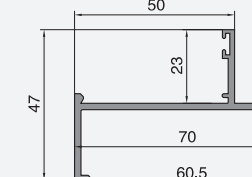
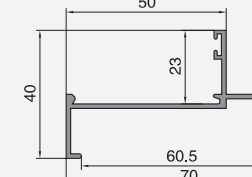
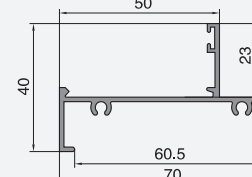
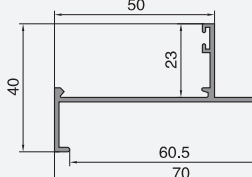

Application	Frame	Application	Frame	Application	Frame	Application	Frame
DWG No.	50B358C	DWG No.	50B362C	DWG No.	50B230C	DWG No.	50B245C
Thickness	$\delta = 1.4$	Thickness	$\delta = 1.4$	Thickness	$\delta = 1.4$	Thickness	$\delta = 1.4$
T.W.	0.709kg/m	T.W.	1.055kg/m	T.W.	0.600kg/m	T.W.	0.661kg/m

4

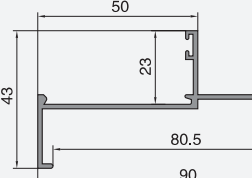
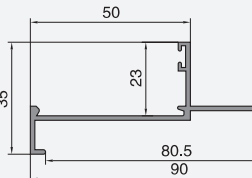
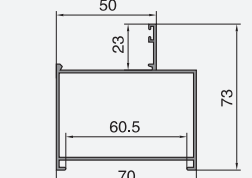
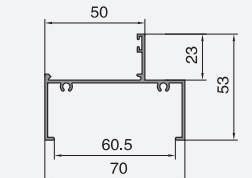

Application	Frame	Application	Frame	Application	Mullion	Application	Mullion
DWG No.	50B247C	DWG No.	50B248C	DWG No.	50B239C	DWG No.	50B29S
Thickness	$\delta = 1.4$	Thickness	$\delta = 1.4$	Thickness	$\delta = 1.4$	Thickness	$\delta = 1.2$
T.W.	0.753kg/m	T.W.	0.832kg/m	T.W.	0.765kg/m	T.W.	0.700kg/m

5

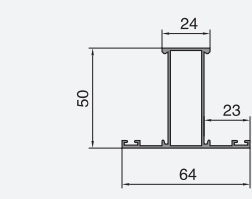
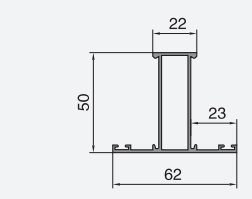
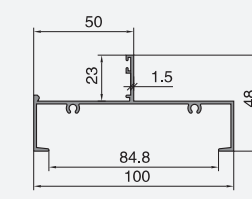
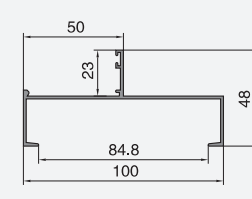



Application	Mullion	Application	Mullion	Application	Mullion	Application	Mullion
DWG No.	50B29N	DWG No.	50B29C	DWG No.	50B29	DWG No.	50B44
Thickness	$\delta = 1.3$	Thickness	$\delta = 1.4$	Thickness	$\delta = 1.6$	Thickness	$\delta = 2.5$
T.W.	0.740kg/m	T.W.	0.780kg/m	T.W.	0.859kg/m	T.W.	1.151kg/m

1

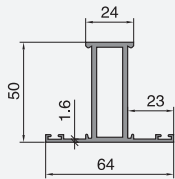
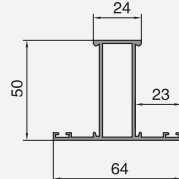
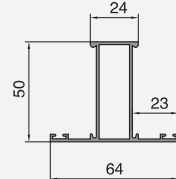
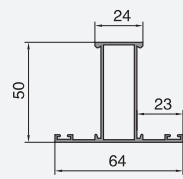

Application	Mullion	Application	Mullion	Application	Mullion	Application	Mullion
DWG No.	50B204S	DWG No.	50B59N	DWG No.	50B59C	DWG No.	50B59K
Thickness	$\delta = 1.4$	Thickness	$\delta = 1.3$	Thickness	$\delta = 1.4$	Thickness	$\delta = 1.6$
T.W.	0.821kg/m	T.W.	0.808kg/m	T.W.	0.848kg/m	T.W.	0.927kg/m

2

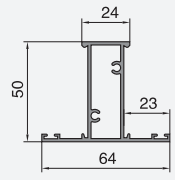
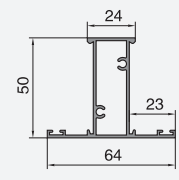
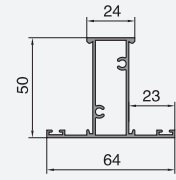
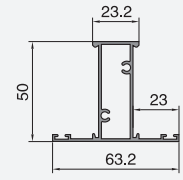

Application	Mullion	Application	Mullion	Application	Mullion	Application	Mullion
DWG No.	50B350C	DWG No.	50B197C	DWG No.	50B161C	DWG No.	50B144K
Thickness	$\delta = 1.4$	Thickness	$\delta = 1.4$	Thickness	$\delta = 1.4$	Thickness	$\delta = 1.6$
T.W.	0.843kg/m	T.W.	1.035kg/m	T.W.	1.238kg/m	T.W.	0.975kg/m

3

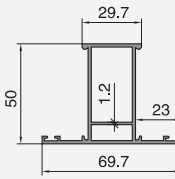
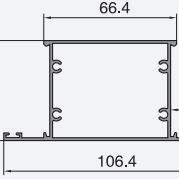
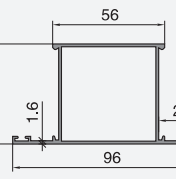
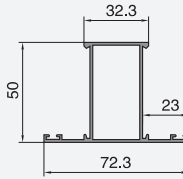

Application	Mullion	Application	Mullion	Application	Mullion	Application	Mullion
DWG No.	50B64C	DWG No.	50B64T	DWG No.	50B54K	DWG No.	50B108D
Thickness	$\delta = 1.4$	Thickness	$\delta = 2.3$	Thickness	$\delta = 1.6$	Thickness	$\delta = 1.5$
T.W.	0.844kg/m	T.W.	1.177kg/m	T.W.	0.992kg/m	T.W.	0.931kg/m

4

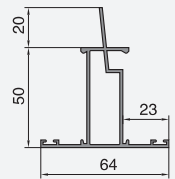
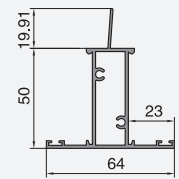
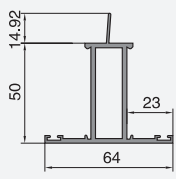
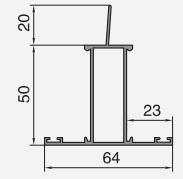

Application	Mullion	Application	Stiffener Mullion	Application	Mullion	Application	Mullion
DWG No.	50B129C	DWG No.	50B399C	DWG No.	50B35C	DWG No.	50B35
Thickness	$\delta = 1.4$	Thickness	$\delta = 1.4$	Thickness	$\delta = 1.4$	Thickness	$\delta = 1.6$
T.W.	0.830kg/m	T.W.	1.153kg/m	T.W.	0.765kg/m	T.W.	0.859kg/m

5

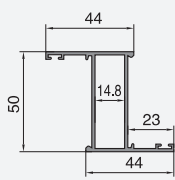
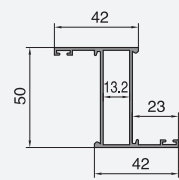
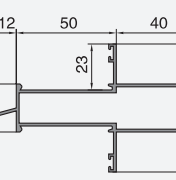
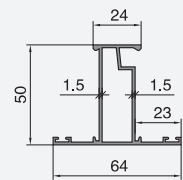

Application	Mullion	Application	Stiffener Mullion	Application	Stiffener Mullion	Application	Stiffener Mullion
DWG No.	50B409C	DWG No.	50B443C	DWG No.	50B298C	DWG No.	50B318C
Thickness	$\delta = 1.4$	Thickness	$\delta = 1.4$	Thickness	$\delta = 1.4$	Thickness	$\delta = 1.4$
T.W.	0.780kg/m	T.W.	1.213kg/m	T.W.	0.970kg/m	T.W.	1.045kg/m

1

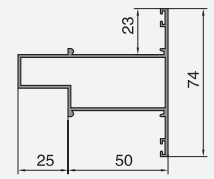
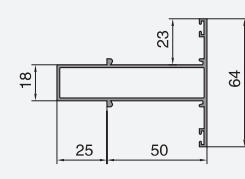
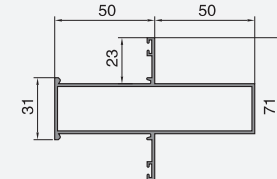
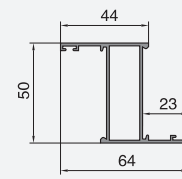

Application	Stiffener Mullion	Application	Stiffener Mullion	Application	Stiffener Mullion	Application	Stiffener Mullion
DWG No.	50B411CS	DWG No.	50B343C	DWG No.	50B377C	DWG No.	50B309C
Thickness	$\delta = 1.4$	Thickness	$\delta = 1.4$	Thickness	$\delta = 1.4$	Thickness	$\delta = 1.4$
T.W.	1.185kg/m	T.W.	0.967kg/m	T.W.	1.037kg/m	T.W.	1.028kg/m

2

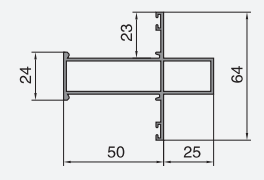
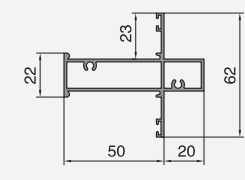
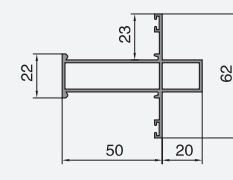
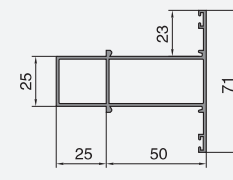

Application	Stiffener Mullion	Application	Stiffener Mullion	Application	Stiffener Mullion	Application	Stiffener Mullion
DWG No.	50B231C	DWG No.	50B335K	DWG No.	50B182C	DWG No.	50B361C
Thickness	$\delta = 1.4$	Thickness	$\delta = 1.6$	Thickness	$\delta = 1.4$	Thickness	$\delta = 1.4$
T.W.	1.106kg/m	T.W.	1.434kg/m	T.W.	0.932kg/m	T.W.	0.974kg/m

3

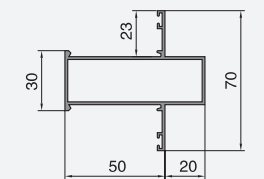
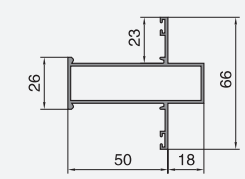
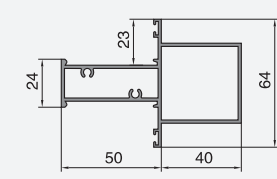
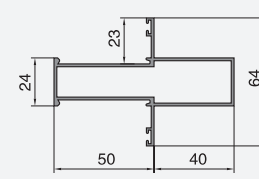

Application	Stiffener Mullion	Application	Stiffener Mullion	Application	Stiffener Mullion	Application	Stiffener Mullion
DWG No.	50B396C	DWG No.	50B364K	DWG No.	50B142T	DWG No.	50B246C
Thickness	$\delta = 1.4$	Thickness	$\delta = 1.6$	Thickness	$\delta = 2.0$	Thickness	$\delta = 1.4$
T.W.	1.314kg/m	T.W.	1.887kg/m	T.W.	1.885kg/m	T.W.	1.403kg/m

4

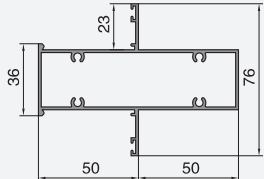
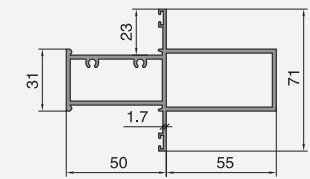
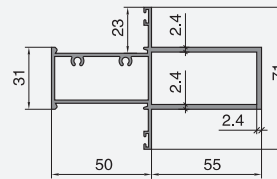
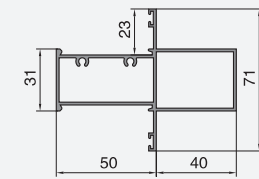

Application	Stiffener Mullion	Application	Stiffener Mullion	Application	Stiffener Mullion	Application	Stiffener Mullion
DWG No.	50B342C	DWG No.	50B351C	DWG No.	50B349CS	DWG No.	50B337H
Thickness	$\delta = 1.4$	Thickness	$\delta = 1.4$	Thickness	$\delta = 1.4$	Thickness	$\delta = 2.0$
T.W.	1.264kg/m	T.W.	1.277kg/m	T.W.	1.429kg/m	T.W.	1.815kg/m

5

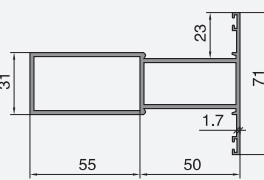
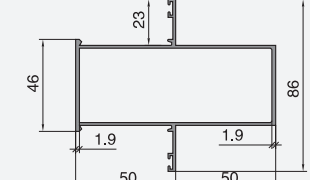
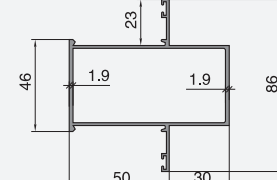
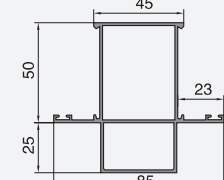



Application	Stiffener Mullion	Application	Stiffener Mullion	Application	Stiffener Mullion	Application	Stiffener Mullion
DWG No.	50B338H	DWG No.	50B373C	DWG No.	50B299C	DWG No.	50B410CS
Thickness	$\delta = 2.0$	Thickness	$\delta = 1.4$	Thickness	$\delta = 1.4$	Thickness	$\delta = 1.4$
T.W.	1.815kg/m	T.W.	0.974kg/m	T.W.	1.046kg/m	T.W.	1.184kg/m

1

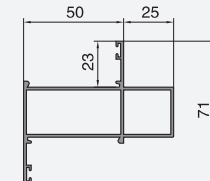
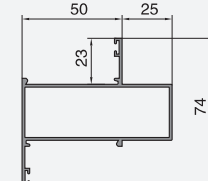
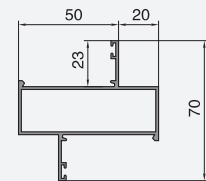
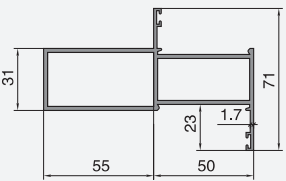

Application	Connector	Application	Connector	Application	Connector	Application	90° Corner Post
DWG No.	50B308E	DWG No.	50B333C	DWG No.	50B33	DWG No.	50B217C
Thickness	$\delta = 1.2$	Thickness	$\delta = 1.4$	Thickness	$\delta = 1.6$	Thickness	$\delta = 1.4$
T.W.	0.610kg/m	T.W.	0.441kg/m	T.W.	0.476kg/m	T.W.	0.682kg/m

2

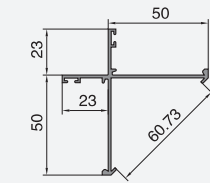
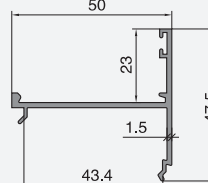
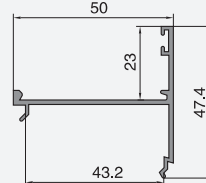
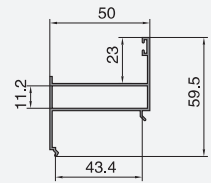

Application	90° Corner Joint	Application	90° Corner Post	Application	90° Corner Post	Application	90° Corner Post
DWG No.	50B218C	DWG No.	50B68N	DWG No.	50B68D	DWG No.	50B68C-A
Thickness	$\delta = 1.4$	Thickness	$\delta = 1.3$	Thickness	$\delta = 1.5$	Thickness	$\delta = 1.4$
T.W.	0.397kg/m	T.W.	0.966kg/m	T.W.	1.157kg/m	T.W.	1.010kg/m

3

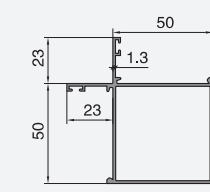
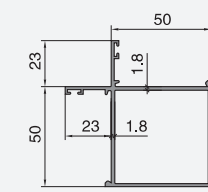
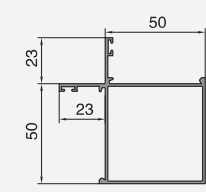
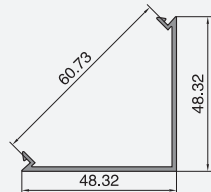

Application	90° Corner Post	Application	90° Corner Post	Application	90° Corner Post	Application	90° Corner Post
DWG No.	50B68-1C	DWG No.	50B183C	DWG No.	50B331	DWG No.	50B72S
Thickness	$\delta = 1.4$	Thickness	$\delta = 1.4$	Thickness	$\delta = 1.2$	Thickness	$\delta = 1.2$
T.W.	0.972kg/m	T.W.	0.961kg/m	T.W.	0.849kg/m	T.W.	0.909kg/m

4

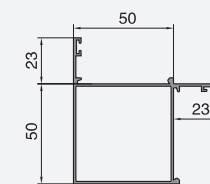
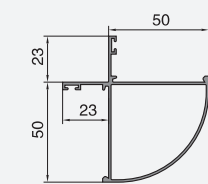
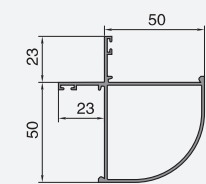
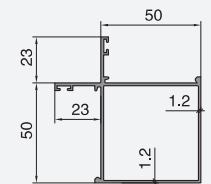

Application	90° Corner Post	Application	90° Corner Post	Application	90° Corner Post	Application	90° Corner Post
DWG No.	50B72D	DWG No.	50B402C	DWG No.	50B314S	DWG No.	50B81D
Thickness	$\delta = 1.5$	Thickness	$\delta = 1.4$	Thickness	$\delta = 1.2$	Thickness	$\delta = 1.5$
T.W.	1.157kg/m	T.W.	1.024kg/m	T.W.	0.847kg/m	T.W.	1.157kg/m

5

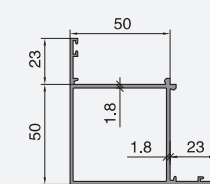
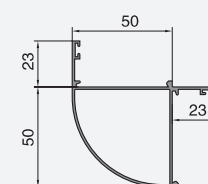
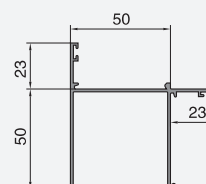
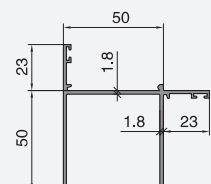

Application	90° Corner Post	Application	90° Corner Post	Application	90° Corner Post	Application	90° Corner Post
DWG No.	50B403C	DWG No.	50B363C	DWG No.	50B372C	DWG No.	50B348C
Thickness	$\delta = 1.4$	Thickness	$\delta = 1.4$	Thickness	$\delta = 1.4$	Thickness	$\delta = 1.4$
T.W.	1.024kg/m	T.W.	1.323kg/m	T.W.	1.323kg/m	T.W.	1.228kg/m

1

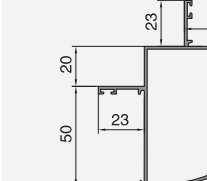
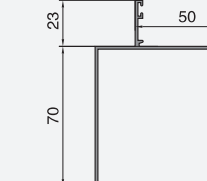
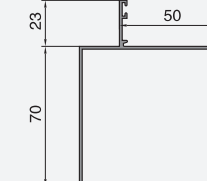
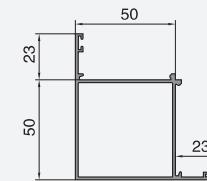

Application	135° Corner Post	Application	135° Corner Post	Application	135° Corner Post	Application	Box section
DWG No.	50B99C	DWG No.	50B99K	DWG No.	50B319C	DWG No.	50B198C
Thickness	$\delta = 1.4$	Thickness	$\delta = 1.6$	Thickness	$\delta = 1.4$	Thickness	$\delta = 1.4$
T.W.	0.952kg/m	T.W.	1.056kg/m	T.W.	0.823kg/m	T.W.	0.949kg/m

2

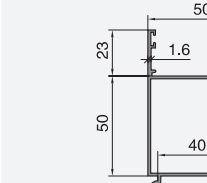
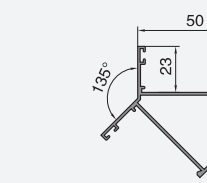
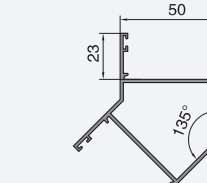
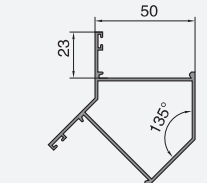

Application	90° Corner Post	Application	90° Corner Post	Application	135° Corner Post	Application	Box section
DWG No.	50B199C	DWG No.	50B240C	DWG No.	50B47	DWG No.	50B36
Thickness	$\delta = 1.4$	Thickness	$\delta = 1.4$	Thickness	$\delta = 1.2$	Thickness	$\delta = 1.5$
T.W.	0.948kg/m	T.W.	0.872kg/m	T.W.	0.816kg/m	T.W.	0.902kg/m

3

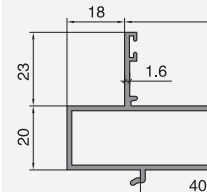
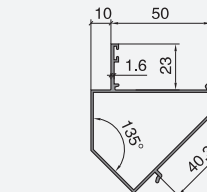
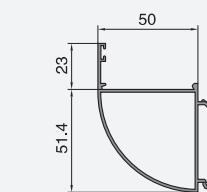
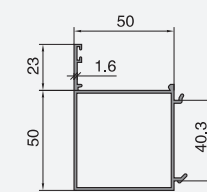

Application	Box section	Application	90° Corner Post	Application	Box section	Application	90° Corner Post
DWG No.	50B37	DWG No.	50B120C	DWG No.	50B42	DWG No.	50B120D
Thickness	$\delta = 1.5$	Thickness	$\delta = 1.4$	Thickness	$\delta = 1.5$	Thickness	$\delta = 1.5$
T.W.	1.065kg/m	T.W.	0.861kg/m	T.W.	1.485kg/m	T.W.	0.912kg/m

4

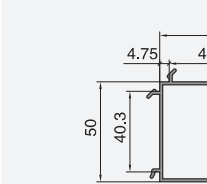
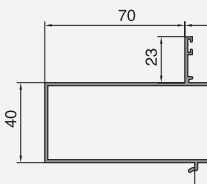
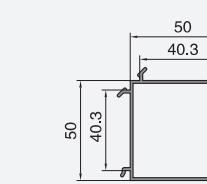
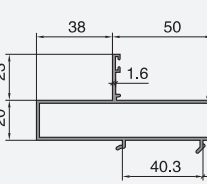

Application	90° Corner Post	Application	90° Corner Post	Application	90° Corner Post	Application	90° Corner Post
DWG No.	50B124	DWG No.	50B124-A	DWG No.	50B13	DWG No.	50B79
Thickness	$\delta = 1.2$	Thickness	$\delta = 1.2$	Thickness	$\delta = 1.5$	Thickness	$\delta = 1.2$
T.W.	0.889kg/m	T.W.	0.894kg/m	T.W.	1.075kg/m	T.W.	0.806kg/m

5

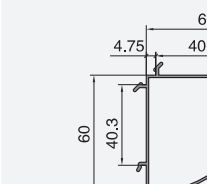
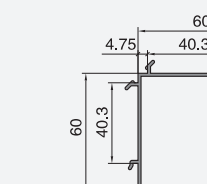
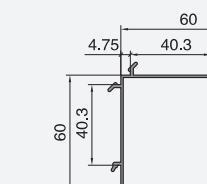
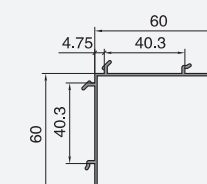



Application	90° Corner Post	Application	90° Corner Post	Application	80° Corner Post	Application	135° Corner Post
DWG No.	50B79C	DWG No.	50E38D	DWG No.	50B235C	DWG No.	50B181C
Thickness	δ = 1.4	Thickness	δ = 1.5	Thickness	δ = 1.4	Thickness	δ = 1.4
T.W.	0.916kg/m	T.W.	1.063kg/m	T.W.	0.876kg/m	T.W.	0.773kg/m
1							
Application	100° Corner Post	Application	101° Corner Post	Application	110° Corner Post	Application	Connector
DWG No.	50B234C	DWG No.	50B176K	DWG No.	50B169K	DWG No.	205091D
Thickness	δ = 1.4	Thickness	δ = 1.6	Thickness	δ = 1.6	Thickness	δ = 1.5
T.W.	0.957kg/m	T.W.	1.388kg/m	T.W.	1.466kg/m	T.W.	0.627kg/m
2							
Application	Connector	Application	Connector	Application	Connector	Application	Connector
DWG No.	50B08	DWG No.	50B31	DWG No.	50B46	DWG No.	50B16
Thickness	δ = 1.5	Thickness	δ = 1.5	Thickness	δ = 2.0	Thickness	δ = 1.5
T.W.	0.839kg/m	T.W.	0.880kg/m	T.W.	1.154kg/m	T.W.	1.023kg/m
3							
Application	Connector	Application	Connector	Application	Connector	Application	Connector
DWG No.	205037T	DWG No.	50B116D	DWG No.	50X05	DWG No.	50B61D
Thickness	δ = 2.0	Thickness	δ = 1.5	Thickness	δ = 1.2	Thickness	δ = 1.5
T.W.	1.632kg/m	T.W.	1.771kg/m	T.W.	0.256kg/m	T.W.	0.408kg/m
4							
Application	Alum. Handle	Application	Flush Plate	Application	Mosquito Frame	Application	In-opening Sash
DWG No.	50B52	DWG No.	2050155	DWG No.	50B51	DWG No.	50B297
Thickness	δ = 3.0	Thickness	δ = 1.2	Thickness	δ = 1.2	Thickness	δ = 1.2
T.W.	0.495kg/m	T.W.	0.110kg/m	T.W.	0.328kg/m	T.W.	0.614kg/m
5			Corner joint	50B50		Corner joint	50B09



Application	In-opening Sash	Application	Out-opening Sash	Application	Out-opening Sash	Application	Out-opening Sash	
DWG No.	50B119D	DWG No.	50B34N	DWG No.	50B34C	DWG No.	50B34	
Thickness	δ = 1.5	Thickness	δ = 1.3	Thickness	δ = 1.4	Thickness	δ = 1.5	
T.W.	0.853kg/m	T.W.	0.658kg/m	T.W.	0.698kg/m	T.W.	0.739kg/m	
1		Corner joint	50B09		Corner joint	50B09		
Application	Out-opening Sash	Application	Out-opening Sash	Application	Out-opening Sash	Application	Out-opening Sash	
DWG No.	50B34D	DWG No.	50B34T	DWG No.	50B34H	DWG No.	50B356C	
Thickness	δ = 1.5	Thickness	δ = 1.7	Thickness	δ = 2.0	Thickness	δ = 1.4	
T.W.	0.843kg/m	T.W.	0.821kg/m	T.W.	0.944kg/m	T.W.	0.743kg/m	
2	Corner joint	YL-9589		Corner joint	50B09		Corner joint	50B09
Application	Out-opening Sash	Application	Out-opening Sash	Application	Out-opening Sash	Application	Out-opening Sash	
DWG No.	50B56N	DWG No.	50B56C	DWG No.	50B56D	DWG No.	50B125C	
Thickness	δ = 1.3	Thickness	δ = 1.4	Thickness	δ = 1.5	Thickness	δ = 1.4	
T.W.	0.756kg/m	T.W.	0.803kg/m	T.W.	0.853kg/m	T.W.	0.849kg/m	
3	Corner joint	50B66		Corner joint	50B66		Corner joint	50B66
Application	Out-opening Sash	Application	Out-opening Sash	Application	Out-opening Sash	Application	Out-opening Sash	
DWG No.	50B149C	DWG No.	50B301C	DWG No.	50B398F	DWG No.	50B128C	
Thickness	δ = 1.4	Thickness	δ = 1.4	Thickness	δ = 1.35	Thickness	δ = 1.4	
T.W.	0.855kg/m	T.W.	0.893kg/m	T.W.	0.805kg/m	T.W.	0.821kg/m	
4	Corner joint	JN50C22		Corner joint	JNHX-5005	Corner joint	JN50C22	
Application	Transom	Application	Transom	Application	Transom	Application	Mullion	
DWG No.	50B65C	DWG No.	50B340D	DWG No.	50B380C	DWG No.	50B130D	
Thickness	δ = 1.4	Thickness	δ = 1.5	Thickness	δ = 1.4	Thickness	δ = 1.5	
T.W.	0.483kg/m	T.W.	0.781kg/m	T.W.	0.754kg/m	T.W.	0.711kg/m	
5								



Application	Flash Bar	Application	Flash Bar	Application	Flash Bar	Application	Frame
DWG No.	MX031	DWG No.	150212(For Powder coating)	DWG No.	YL-156(For anodizing)	DWG No.	50B28H
Thickness	$\delta=2.2$	Thickness	—	Thickness	—	Thickness	$\delta=2.0$
T.W.	0.131kg/m	T.W.	0.160kg/m	T.W.	0.174kg/m	T.W.	0.615kg/m
1							
Application	Frame	Application	Frame	Application	Frame	Application	Frame
DWG No.	50B53T	DWG No.	50B151H	DWG No.	50B152H	DWG No.	50B63H
Thickness	$\delta=2.0$	Thickness	$\delta=2.0$	Thickness	$\delta=2.0$	Thickness	$\delta=2.0$
T.W.	0.690kg/m	T.W.	0.691kg/m	T.W.	0.759kg/m	T.W.	0.890kg/m
2					Corner joint	50B09	
Application	Frame	Application	Mullion	Application	—	Application	Out-opening Sash
DWG No.	50B392G	DWG No.	50B59H	DWG No.	50B119H	DWG No.	50B56T
Thickness	$\delta=1.9$	Thickness	$\delta=2.0$	Thickness	$\delta=2.0$	Thickness	$\delta=2.0$
T.W.	1.135kg/m	T.W.	1.071kg/m	T.W.	1.102kg/m	T.W.	1.099kg/m
3					Corner joint	50B66	
Application	Out-opening Sash	Application	Out-opening Sash	Application	Out-opening Sash	Application	Out-opening Sash
DWG No.	50B150H	DWG No.	50B188H	DWG No.	50B125T	DWG No.	50B441H
Thickness	$\delta=2.0$	Thickness	$\delta=2.0$	Thickness	$\delta=1.8$	Thickness	$\delta=2.0$
T.W.	1.226kg/m	T.W.	1.205kg/m	T.W.	1.092kg/m	T.W.	1.261kg/m
4					Corner joint	JN5811	
Application	Out-opening Sash	Application	Transom	Application	Transom	Application	Mullion
DWG No.	50B391G	DWG No.	50B67H	DWG No.	50B67C	DWG No.	50B344H
Thickness	$\delta=1.9$	Thickness	$\delta=2.0$	Thickness	$\delta=1.4$	Thickness	$\delta=2.0$
T.W.	1.235kg/m	T.W.	1.739kg/m	T.W.	1.250kg/m	T.W.	0.896kg/m
5					Corner joint	YL-365008	



Application	Mullion	Application	Connector	Application	Sill	Application	Sill
DWG No.	50B156K	DWG No.	50B442C	DWG No.	M160-27	DWG No.	LK12524
Thickness	$\delta=1.6$	Thickness	$\delta=1.4$	Thickness	$\delta=2.0$	Thickness	$\delta=2.0$
T.W.	0.583kg/m	T.W.	0.611kg/m	T.W.	0.263kg/m	T.W.	0.175kg/m
1							
Application	Single-glazing Bead for Frame	Application	Single-glazing Bead for Frame	Application	Single-glazing Bead for Frame	Application	Single-glazing Bead for Frame
DWG No.	50B232	DWG No.	50B404	DWG No.	50B300	DWG No.	50B30
Thickness	$\delta=0.8$	Thickness	$\delta=0.9$	Thickness	$\delta=0.9$	Thickness	$\delta=1.1$
T.W.	0.177kg/m	T.W.	0.192kg/m	T.W.	0.192kg/m	T.W.	0.232kg/m
2							
Application	Single-glazing Bead for Frame	Application	Single-glazing Bead for Frame	Application	Single-glazing Bead for Frame	Application	Single-glazing Bead for Frame
DWG No.	50B30-1	DWG No.	50B219	DWG No.	50B78	DWG No.	50B78-1
Thickness	$\delta=0.9$	Thickness	$\delta=1.0$	Thickness	$\delta=1.5$	Thickness	$\delta=1.0$
T.W.	0.192kg/m	T.W.	0.212kg/m	T.W.	0.325kg/m	T.W.	0.256kg/m
3							
Application	Single-glazing Bead for Frame	Application	Double-glazing Bead for Frame	Application	Double-glazing Bead for Frame	Application	Double-glazing Bead for Frame
DWG No.	50B141	DWG No.	50B123	DWG No.	50B85	DWG No.	50B180
Thickness	$\delta=1.1$	Thickness	$\delta=1.1$	Thickness	$\delta=1.1$	Thickness	$\delta=1.0$
T.W.	0.301kg/m	T.W.	0.271kg/m	T.W.	0.243kg/m	T.W.	0.258kg/m
4							
Application	Double-glazing Bead for Frame	Application	Double-glazing Bead for Frame	Application	Double-glazing Bead for Frame	Application	Double-glazing Bead for Frame
DWG No.	50B58	DWG No.	50B365	DWG No.	50B209	DWG No.	50B88
Thickness	$\delta=1.1$	Thickness	$\delta=0.8$	Thickness	$\delta=1.1$	Thickness	$\delta=1.1$
T.W.	0.246kg/m	T.W.	0.184kg/m	T.W.	0.279kg/m	T.W.	0.270kg/m
5							



Application	Double-glazing Bead for Frame	Application	Double-glazing Bead for Frame	Application	Double-glazing Bead for Frame	Application	Double-glazing Bead for Frame
DWG No.	50B284	DWG No.	50B140	DWG No.	50B39	DWG No.	50B83
Thickness	$\delta = 1.1$	Thickness	$\delta = 1.1$	Thickness	$\delta = 1.1$	Thickness	$\delta = 1.1$
T.W.	0.247kg/m	T.W.	0.300kg/m	T.W.	0.248kg/m	T.W.	0.279kg/m
1							
Application	Double-glazing Bead for Frame	Application	Single-glazing Bead for Sash	Application	Single-glazing Bead for Sash	Application	Single-glazing Bead for Sash
DWG No.	50B407	DWG No.	50B233	DWG No.	50B38	DWG No.	50B38-B
Thickness	$\delta = 1.1$	Thickness	$\delta = 0.8$	Thickness	$\delta = 1.1$	Thickness	$\delta = 0.9$
T.W.	0.278kg/m	T.W.	0.156kg/m	T.W.	0.189kg/m	T.W.	0.156kg/m
2							
Application	Single-glazing Bead for Sash	Application	Single-glazing Bead for Sash	Application	Double-glazing Bead for Sash	Application	Double-glazing Bead for Sash
DWG No.	50B77	DWG No.	50B77-1	DWG No.	50B133	DWG No.	50B122
Thickness	$\delta = 1.5$	Thickness	$\delta = 1.0$	Thickness	$\delta = 1.1$	Thickness	$\delta = 1.1$
T.W.	0.277kg/m	T.W.	0.213kg/m	T.W.	0.190kg/m	T.W.	0.232kg/m
3							
Application	Double-glazing Bead for Sash	Application	Double-glazing Bead for Sash	Application	Double-glazing Bead for Sash	Application	Double-glazing Bead for Sash
DWG No.	50B173	DWG No.	50B336	DWG No.	50B57	DWG No.	50B57-A
Thickness	$\delta = 1.1$	Thickness	$\delta = 1.0$	Thickness	$\delta = 1.1$	Thickness	$\delta = 0.7$
T.W.	0.189kg/m	T.W.	0.213kg/m	T.W.	0.200kg/m	T.W.	0.134kg/m
4							
Application	Double-glazing Bead for Sash	Application	Double-glazing Bead for Sash	Application	Double-glazing Bead for Sash	Application	Double-glazing Bead for Sash
DWG No.	50B57R	DWG No.	50B87	DWG No.	50B208	DWG No.	50B40
Thickness	$\delta = 0.8$	Thickness	$\delta = 1.1$	Thickness	$\delta = 1.1$	Thickness	$\delta = 1.1$
T.W.	0.151kg/m	T.W.	0.222kg/m	T.W.	0.231kg/m	T.W.	0.203kg/m
5							

Application	Double-glazing Bead for Sash	Application	Double-glazing Bead for Sash	Application	Angle	Application	Angle
DWG No.	50B82	DWG No.	50B359	DWG No.	YL-9589	DWG No.	50B09
Thickness	$\delta = 1.1$	Thickness	$\delta = 1.1$	Thickness	---	Thickness	---
T.W.	0.230kg/m	T.W.	0.230kg/m	T.W.	2.233kg/m	T.W.	1.514kg/m
1							
Application	Angle	Application	Angle	Application	Angle	Application	Angle
DWG No.	50B113	DWG No.	50B162	DWG No.	EAW6321	DWG No.	JW5012
Thickness	---	Thickness	---	Thickness	---	Thickness	$\delta = 3.0$
T.W.	1.524kg/m	T.W.	1.109kg/m	T.W.	2.419kg/m	T.W.	1.865kg/m
2							
Application	Angle	Application	Angle	Application	Angle	Application	Angle
DWG No.	JN50C22	DWG No.	50B375	DWG No.	50W25	DWG No.	JNHX-5005
Thickness	---	Thickness	$\delta = 2.0$	Thickness	$\delta = 4.0$	Thickness	---
T.W.	3.054kg/m	T.W.	1.507kg/m	T.W.	2.040kg/m	T.W.	2.323kg/m
3							
Application	Angle	Application	Angle	Application	Angle	Application	Angle
DWG No.	50B244	DWG No.	50B66	DWG No.	50B137	DWG No.	JN5811
Thickness	$\delta = 3.0$	Thickness	$\delta = 3.0$	Thickness	$\delta = 3.0$	Thickness	$\delta = 3.0$
T.W.	2.130kg/m	T.W.	2.780kg/m	T.W.	3.079kg/m	T.W.	2.878kg/m
4							
Application	Angle	Application	Angle	Application	Angle	Application	Angle
DWG No.	50B126	DWG No.	YL-5169	DWG No.	YL-9205	DWG No.	YL-375010
Thickness	$\delta = 3.0$	Thickness	$\delta = 3.0$	Thickness	---	Thickness	$\delta = 5.8$
T.W.	3.562kg/m	T.W.	3.602kg/m	T.W.	6.690kg/m	T.W.	7.559kg/m
5							



Application	Angle	Application	Angle
DWG No.	YL-365008	DWG No.	MX190
Thickness	$\delta = 6.0$	Thickness	$\delta = 4.0$
T.W.	7.737kg/m	T.W.	5.315kg/m

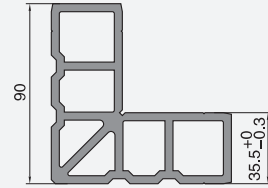
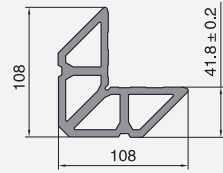

1



Y2KS System Sliding Window

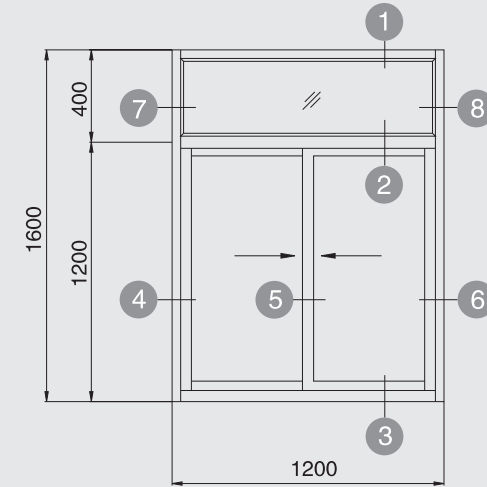

Window area	1.92 m ²
Unit weight	5.54 kg/m ²

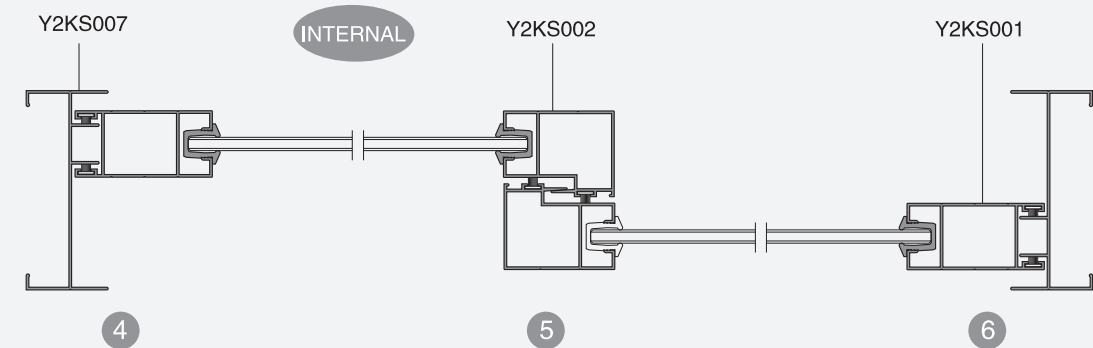
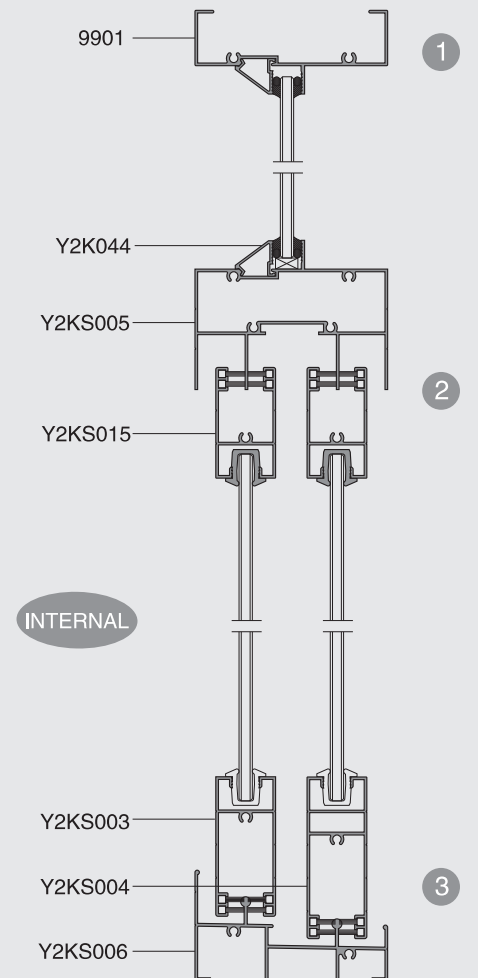
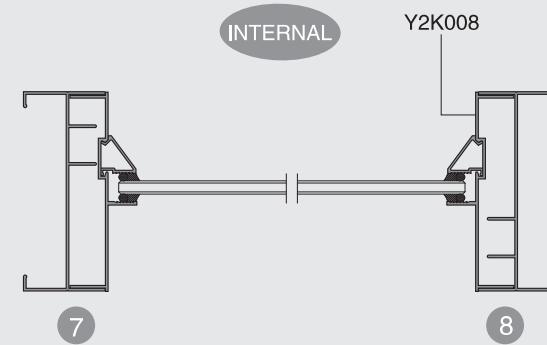



Y2KS System Sliding Window with inner Flyscreen

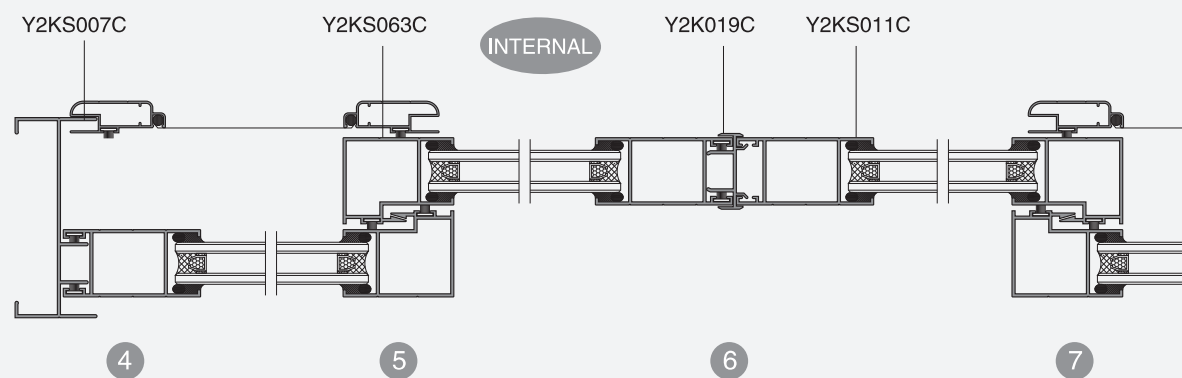
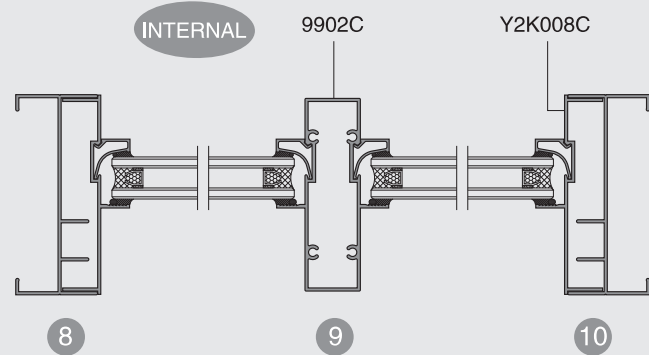
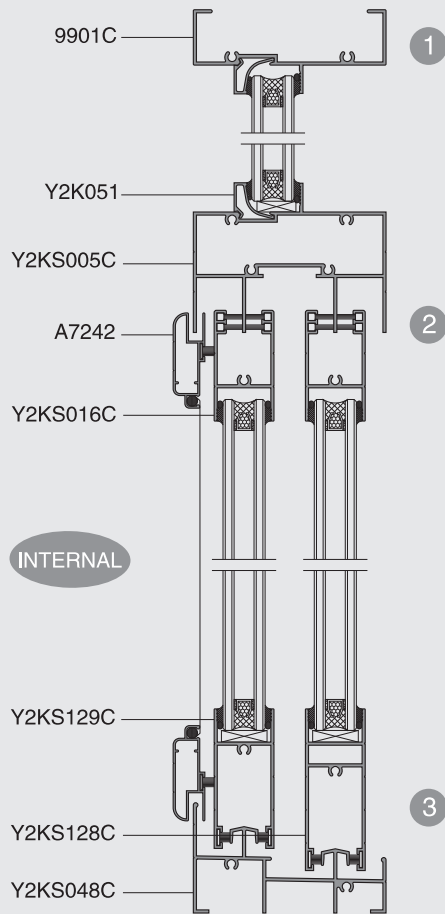
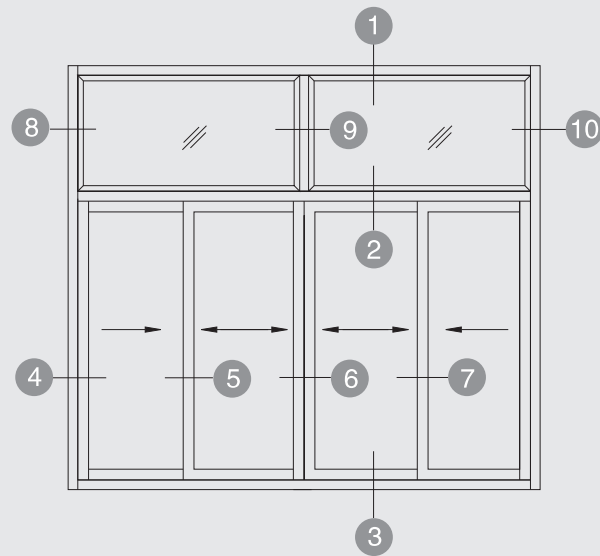

Application	Head	Application	Head	Application	Head	Application	Head
DWG No.	Y2KS009	DWG No.	Y2KS009C	DWG No.	Y2KS009K	DWG No.	Y2KS009T
Thickness	$\delta = 1.2$	Thickness	$\delta = 1.4$	Thickness	$\delta = 1.6$	Thickness	$\delta = 1.8$
T.W.	0.788kg/m	T.W.	0.903kg/m	T.W.	1.027kg/m	T.W.	1.160kg/m

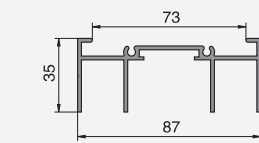
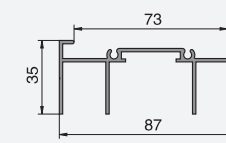
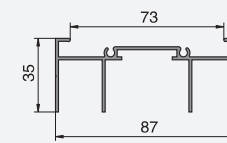
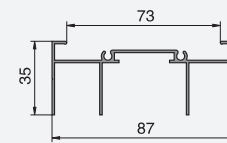

Application	Head	Application	Head	Application	Head	Application	Head
DWG No.	Y2KS228C	DWG No.	Y2KS074N	DWG No.	Y2KS005	DWG No.	Y2KS005C
Thickness	$\delta = 1.4$	Thickness	$\delta = 1.3$	Thickness	$\delta = 1.2$	Thickness	$\delta = 1.4$
T.W.	1.035kg/m	T.W.	1.147kg/m	T.W.	1.280kg/m	T.W.	1.459kg/m

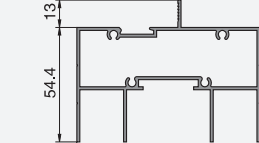
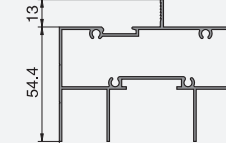
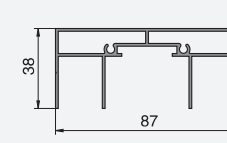
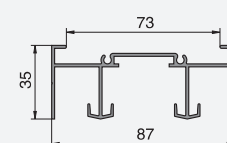

Application	Head	Application	Sill	Application	Sill	Application	Sill
DWG No.	Y2KS005T	DWG No.	Y2KS006	DWG No.	Y2KS006C	DWG No.	Y2KS006T
Thickness	$\delta = 1.8$	Thickness	$\delta = 1.2$	Thickness	$\delta = 1.4$	Thickness	$\delta = 1.8$
T.W.	1.880kg/m	T.W.	0.940kg/m	T.W.	1.018kg/m	T.W.	1.280kg/m

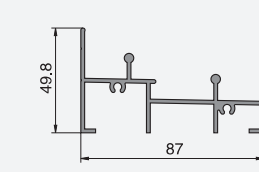
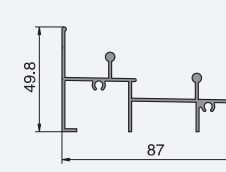
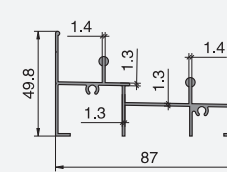
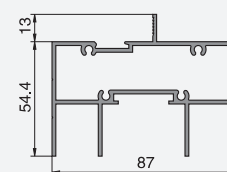

Application	Sill	Application	Sill	Application	Sill	Application	Sill
DWG No.	Y2KS150S	DWG No.	Y2KS150C	DWG No.	Y2KS040T	DWG No.	Y2KS028
Thickness	$\delta = 1.2$	Thickness	$\delta = 1.4$	Thickness	$\delta = 1.8$	Thickness	$\delta = 1.2$
T.W.	0.810kg/m	T.W.	0.877kg/m	T.W.	1.233kg/m	T.W.	1.191kg/m

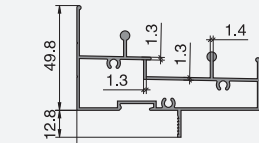
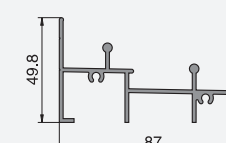
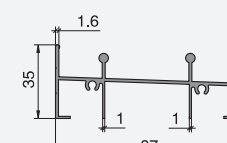
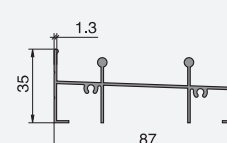

Application	Sill	Application	Sill	Application	Sill	Application	Sill
DWG No.	Y2KS028C	DWG No.	Y2KS099	DWG No.	Y2KS048C	DWG No.	Y2KS048K
Thickness	$\delta = 1.4$	Thickness	$\delta = 1.2$	Thickness	$\delta = 1.4$	Thickness	$\delta = 1.6$
T.W.	1.301kg/m	T.W.	1.116kg/m	T.W.	1.116kg/m	T.W.	1.262kg/m

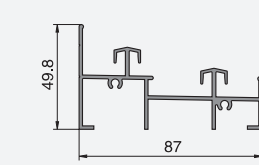
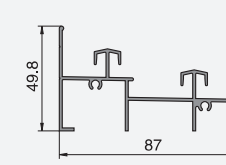
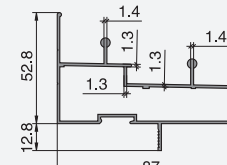
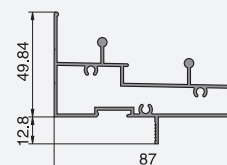



1	Application	Sill	Application	Sill	Application	Sill	Application	Sill
	DWG No.	Y2KS086C	DWG No.	Y2KS073N	DWG No.	Y2KS151C	DWG No.	Y2KS216C
	Thickness	δ =1.4	Thickness	δ =1.3	Thickness	δ =1.4	Thickness	δ =1.4
	T.W.	1.136kg/m	T.W.	1.253kg/m	T.W.	1.232kg/m	T.W.	1.097kg/m
2	Application	Sill	Application	Sill	Application	Sill	Application	Sill
	DWG No.	Y2KS217	DWG No.	Y2KS190C	DWG No.	Y2KS240C	DWG No.	Y2KS152C
	Thickness	δ =1.2	Thickness	δ =1.4	Thickness	δ =1.4	Thickness	δ =1.4
	T.W.	0.965kg/m	T.W.	0.964kg/m	T.W.	0.878kg/m	T.W.	1.492kg/m
3	Application	Sill	Application	Jamb	Application	Jamb	Application	Jamb
	DWG No.	Y2KS087C	DWG No.	Y2KS007	DWG No.	Y2KS007C	DWG No.	Y2KS007CY
	Thickness	δ =1.4	Thickness	δ =1.2	Thickness	δ =1.4	Thickness	δ =1.4
	T.W.	1.423kg/m	T.W.	0.643kg/m	T.W.	0.748kg/m	T.W.	0.746kg/m
4	Application	Jamb	Application	Jamb	Application	Jamb	Application	Jamb
	DWG No.	Y2KS007K	DWG No.	Y2KS007T	DWG No.	Y2KS007H	DWG No.	Y2KS072N
	Thickness	δ =1.6	Thickness	δ =1.8	Thickness	δ =2.0	Thickness	δ =1.3
	T.W.	0.856kg/m	T.W.	0.956kg/m	T.W.	1.062kg/m	T.W.	0.965kg/m
5	Application	Jamb	Application	Jamb insert plate	Application	Jamb insert plate	Application	Jamb insert plate
	DWG No.	Y2KS202D	DWG No.	Y2K008B	DWG No.	Y2K008	DWG No.	Y2K008C
	Thickness	δ =1.5	Thickness	δ =1.1	Thickness	δ =1.2	Thickness	δ =1.4
	T.W.	0.903kg/m	T.W.	0.479kg/m	T.W.	0.476kg/m	T.W.	0.542kg/m

1	Application	Jamb insert plate	Application	Jamb reverse insert plate	Application	reverse insert plate	Application	Fixed Frame
	DWG No.	Y2K008T	DWG No.	Y2KS085T	DWG No.	Y2KS276	DWG No.	9901
	Thickness	δ =1.8	Thickness	δ =1.8	Thickness	δ =1.2	Thickness	δ =1.2
	T.W.	0.698kg/m	T.W.	0.730kg/m	T.W.	0.446kg/m	T.W.	0.628kg/m
2	Application	Fixed Frame	Application	Fixed Frame	Application	Mullion	Application	Mullion
	DWG No.	9901C	DWG No.	9901H	DWG No.	9902	DWG No.	9902C
	Thickness	δ =1.4	Thickness	δ =1.8	Thickness	δ =1.2	Thickness	δ =1.4
	T.W.	0.719kg/m	T.W.	0.847kg/m	T.W.	1.001kg/m	T.W.	1.143kg/m
3	Application	90° Corner filler	Application	90° Corner filler	Application	90° Corner Post	Application	90° Corner Post
	DWG No.	Y2KS029	DWG No.	Y2KS029C	DWG No.	Y2KS098	DWG No.	Y2KS030
	Thickness	δ =1.2	Thickness	δ =1.4	Thickness	δ =1.2	Thickness	δ =1.2
	T.W.	1.403kg/m	T.W.	1.612kg/m	T.W.	1.294kg/m	T.W.	1.294kg/m
4	Application	90° Corner Post	Application	90° Corner Post	Application	90° Corner Post	Application	90° Corner Post
	DWG No.	Y2KS030C	DWG No.	Y2K021	DWG No.	Y2K053	DWG No.	Y2K054
	Thickness	δ =1.4	Thickness	δ =1.2	Thickness	δ =1.2	Thickness	δ =1.2
	T.W.	1.503kg/m	T.W.	1.142kg/m	T.W.	1.268kg/m	T.W.	1.268kg/m
5	Application	135° Corner Post	Application	80° Corner Post	Application	Box section	Application	Box section
	DWG No.	Y2K022	DWG No.	Y2K129S	DWG No.	Y2K020	DWG No.	Y2K020C
	Thickness	δ =1.2	Thickness	δ =1.4	Thickness	δ =1.2	Thickness	δ =1.4
	T.W.	1.005kg/m	T.W.	1.256kg/m	T.W.	0.810kg/m	T.W.	0.927kg/m



1	Application Connector	Application ———	Application Single Top Rail	Application Single Top Rail
	DWG No. Y2K026	DWG No. Y2K050	DWG No. Y2KS015	DWG No. Y2KS015C
	Thickness δ = 1.2 T.W. 0.457kg/m	Thickness δ = 1.2 T.W. 0.227kg/m	Thickness δ = 1.2 T.W. 0.593kg/m	Thickness δ = 1.4 T.W. 0.654kg/m
2	Application Single Top Rail	Application Single Top Rail	Application Single Bottom Rail	Application Single Bottom Rail
	DWG No. Y2KS015K	DWG No. Y2KS015T	DWG No. Y2KS003	DWG No. Y2KS003C
	Thickness δ = 1.6 T.W. 0.730kg/m	Thickness δ = 1.8 T.W. 0.823kg/m	Thickness δ = 1.2 T.W. 0.677kg/m	Thickness δ = 1.4 T.W. 0.747kg/m
3	Application sill for out-side glazing	Application Single Bottom Rail	Application Single Bottom Rail	Application Single Bottom Rail
	DWG No. Y2KS003T	DWG No. Y2KS046	DWG No. Y2KS046C	DWG No. Y2KS046K
	Thickness δ = 1.8 T.W. 0.947kg/m	Thickness δ = 1.2 T.W. 0.631kg/m	Thickness δ = 1.4 T.W. 0.701kg/m	Thickness δ = 1.6 T.W. 0.795kg/m
4	Application sill for out-side glazing	Application sill for out-side glazing	Application sill for out-side glazing	Application sill for out-side glazing
	DWG No. Y2KS004	DWG No. Y2KS004C	DWG No. Y2KS004T	DWG No. Y2KS047
	Thickness δ = 1.2 T.W. 0.821kg/m	Thickness δ = 1.4 T.W. 0.914kg/m	Thickness δ = 1.8 T.W. 1.161kg/m	Thickness δ = 1.2 T.W. 0.775kg/m
5	Application sill for out-side glazing	Application sill for out-side glazing	Application Single Interlock	Application Single Interlock
	DWG No. Y2KS047C	DWG No. Y2KS047K	DWG No. Y2KS002	DWG No. Y2KS002C
	Thickness δ = 1.4 T.W. 0.868kg/m	Thickness δ = 1.6 T.W. 0.986kg/m	Thickness δ = 1.2 T.W. 0.684kg/m	Thickness δ = 1.4 T.W. 0.78kg/m

1	Application Single Interlock	Application Single Interlock	Application Single Interlock	Application Single Hav. Interlock
	DWG No. Y2KS002K	DWG No. Y2KS002T	DWG No. Y2KS062C	DWG No. Y2KS031C
	Thickness δ = 1.6 T.W. 0.879kg/m	Thickness δ = 1.8 T.W. 0.987kg/m	Thickness δ = 1.4 T.W. 0.797kg/m	Thickness δ = 1.4 T.W. 1.246kg/m
2	Application Single Hav. Interlock	Application Single Hav. Interlock	Application Single Hav. Interlock	Application Single Stile
	DWG No. Y2KS089C	DWG No. Y2KS064C	DWG No. Y2KS042T	DWG No. Y2KS001
	Thickness δ = 1.4 T.W. 1.293kg/m	Thickness δ = 1.4 T.W. 1.263kg/m	Thickness δ = 1.8 T.W. 2.080kg/m	Thickness δ = 1.2 T.W. 0.702kg/m
3	Application Single Stile	Application Single Stile	Application Single Stile	Application Single Stile
	DWG No. Y2KS001C	DWG No. Y2KS001K	DWG No. Y2KS001T	DWG No. Y2KS189T
	Thickness δ = 1.4 T.W. 0.806kg/m	Thickness δ = 1.6 T.W. 0.919kg/m	Thickness δ = 1.8 T.W. 1.033kg/m	Thickness δ = 1.8 T.W. 1.114kg/m
4	Application Single Hav. Stile	Application Double Top Rail	Application Double Top Rail	Application Double Top Rail
	DWG No. Y2KS038T	DWG No. Y2KS016C	DWG No. Y2KS016T	DWG No. Y2KS229C
	Thickness δ = 1.8 T.W. 2.100kg/m	Thickness δ = 1.4 T.W. 0.583kg/m	Thickness δ = 1.8 T.W. 0.735kg/m	Thickness δ = 1.4 T.W. 0.538kg/m
5	Application Double Bottom Rail	Application Double Bottom Rail	Application Double Bottom Rail	Application sill for out-side glazing
	DWG No. Y2KS013C	DWG No. Y2KS013T	DWG No. Y2KS129C	DWG No. Y2KS014C
	Thickness δ = 1.4 T.W. 0.678kg/m	Thickness δ = 1.8 T.W. 0.861kg/m	Thickness δ = 1.4 T.W. 0.632kg/m	Thickness δ = 1.4 T.W. 0.845kg/m



Application	sill for out-side glazing	Application	sill for out-side glazing	Application	Double Interlock	Application	Double Interlock
DWG No.	Y2KS014T	DWG No.	Y2KS128C	DWG No.	Y2KS012C	DWG No.	Y2KS012T
Thickness	δ =1.8	Thickness	δ =1.4	Thickness	δ =1.4	Thickness	δ =1.8
T.W.	1.072kg/m	T.W.	0.799kg/m	T.W.	0.714kg/m	T.W.	0.909kg/m

1

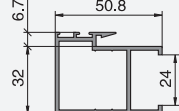
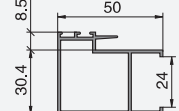
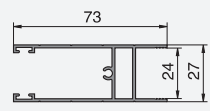
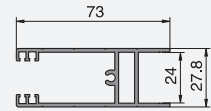

Application	Double Interlock	Application	Double Hav. Interlock	Application	Double Hav. Interlock	Application	Double Hav. Interlock
DWG No.	Y2KS063C	DWG No.	Y2KS061C	DWG No.	Y2KS061T	DWG No.	Y2KS208C
Thickness	δ =1.4	Thickness	δ =1.4	Thickness	δ =1.8	Thickness	δ =1.4
T.W.	0.738kg/m	T.W.	1.204kg/m	T.W.	1.455kg/m	T.W.	1.019kg/m

2

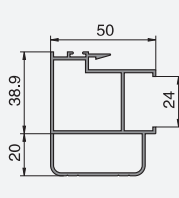
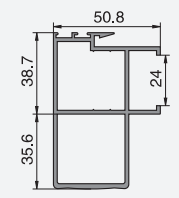
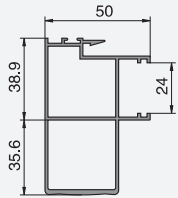
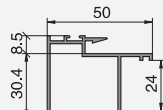

Application	Double Hav. Interlock	Application	Double Stile	Application	Double Stile	Application	Double Stile
DWG No.	Y2KS090C	DWG No.	Y2KS011C	DWG No.	Y2KS011T	DWG No.	Y2KS091C
Thickness	δ =1.4	Thickness	δ =1.4	Thickness	δ =1.8	Thickness	δ =1.4
T.W.	1.248kg/m	T.W.	0.740kg/m	T.W.	0.960kg/m	T.W.	0.755kg/m

3

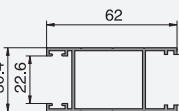
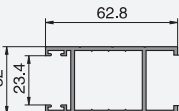
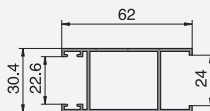
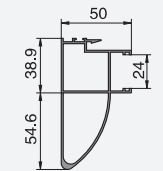

Application	Double Stile	Application	Double Hav. Stile	Application	Transom	Application	Transom
DWG No.	Y2KS201C	DWG No.	Y2KS207C	DWG No.	Y2KS206C	DWG No.	Y2KS237C
Thickness	δ =1.4	Thickness	δ =1.4	Thickness	δ =1.4	Thickness	δ =1.4
T.W.	0.826kg/m	T.W.	1.040kg/m	T.W.	0.794kg/m	T.W.	0.707kg/m

4

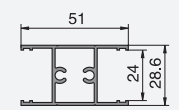
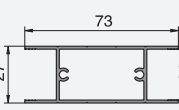
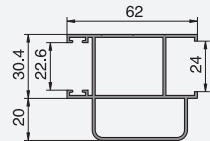
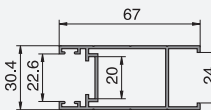

Application	Double Top Rail	Application	Double Bottom Rail	Application	Double Interlock	Application	Double Stile
DWG No.	G9015C	DWG No.	G9016C	DWG No.	G9017C	DWG No.	G9018C
Thickness	δ =1.4	Thickness	δ =1.4	Thickness	δ =1.4	Thickness	δ =1.4
T.W.	0.561kg/m	T.W.	0.642kg/m	T.W.	0.710kg/m	T.W.	0.701kg/m

5

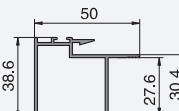
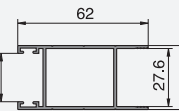
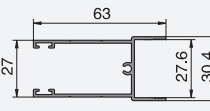
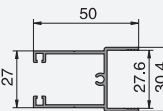

Application	Stile Adapter	Application	Stile Adapter	Application	Stile Adapter	Application	Stile Adapter
DWG No.	Y2K019	DWG No.	Y2K019C	DWG No.	Y2K019K	DWG No.	Y2K019T
Thickness	δ =1.2	Thickness	δ =1.4	Thickness	δ =1.2	Thickness	δ =1.8
T.W.	0.265kg/m	T.W.	0.309kg/m	T.W.	0.283kg/m	T.W.	0.394kg/m

1

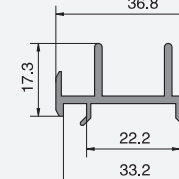
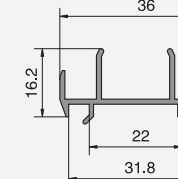
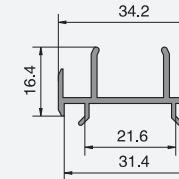
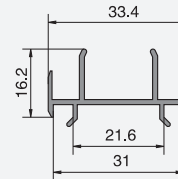



Y2KS System Wide-track Sliding Door

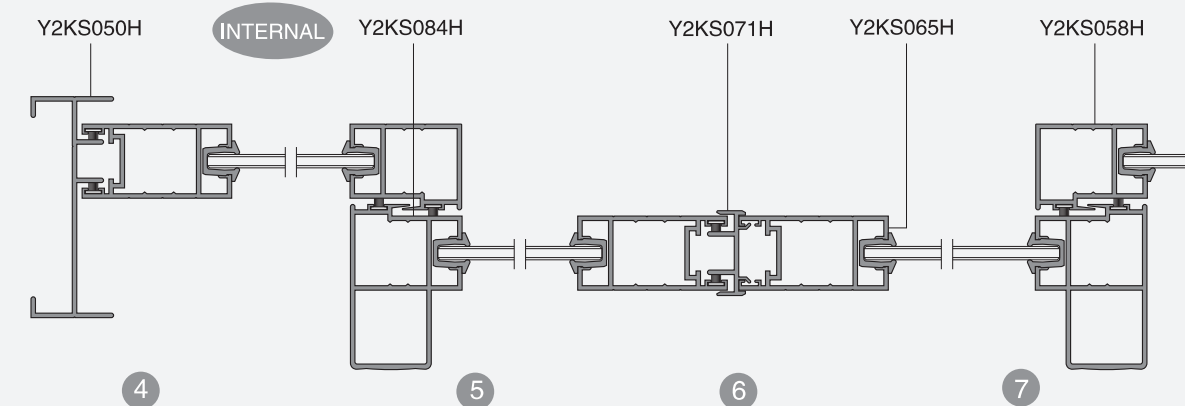
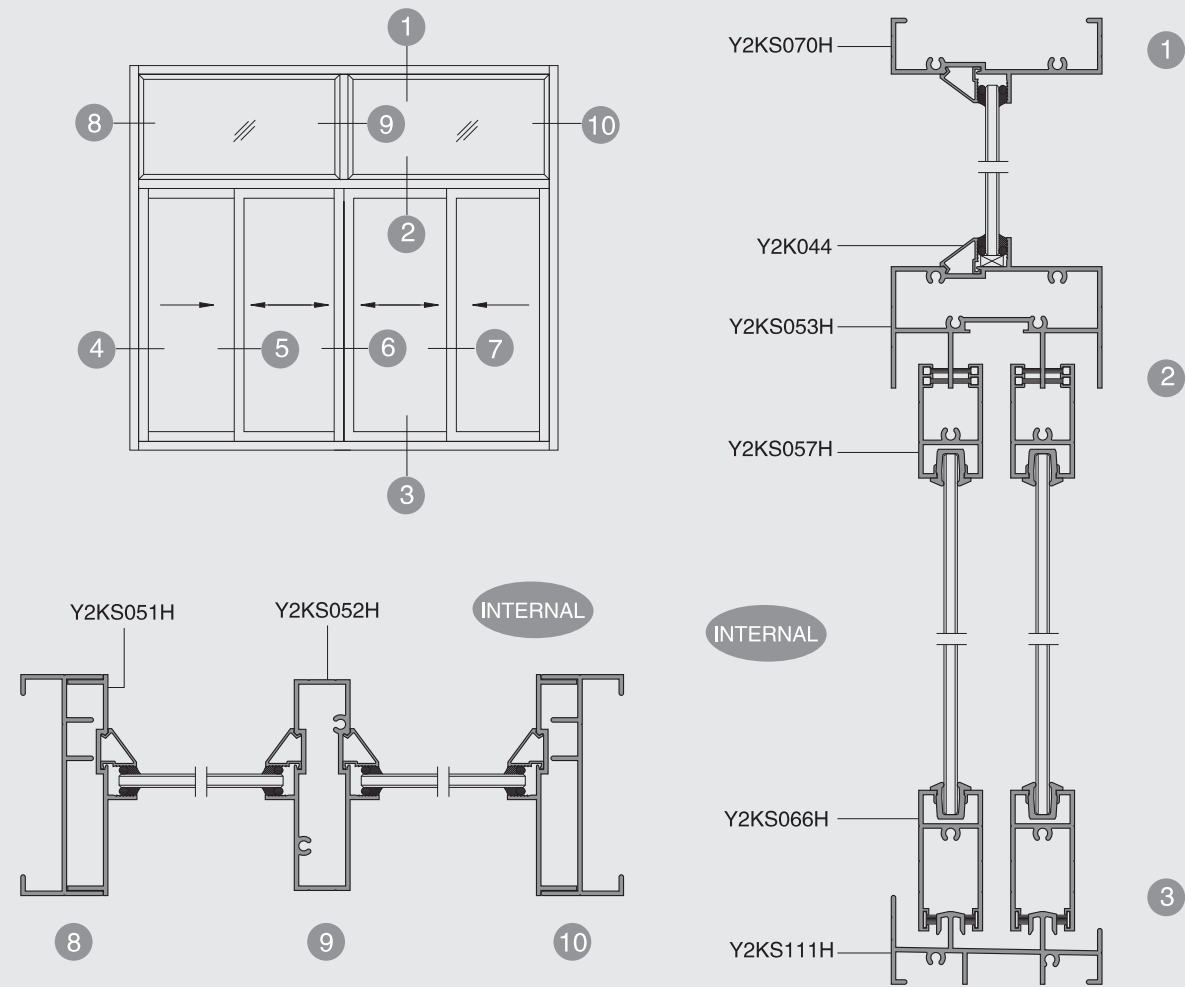

Y2KS System Wide-track Sliding Door(with outer Flyscreen)

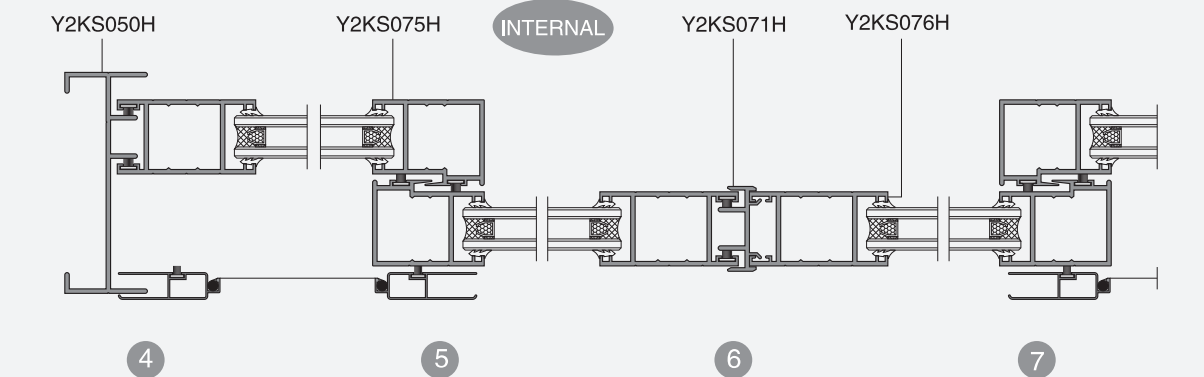
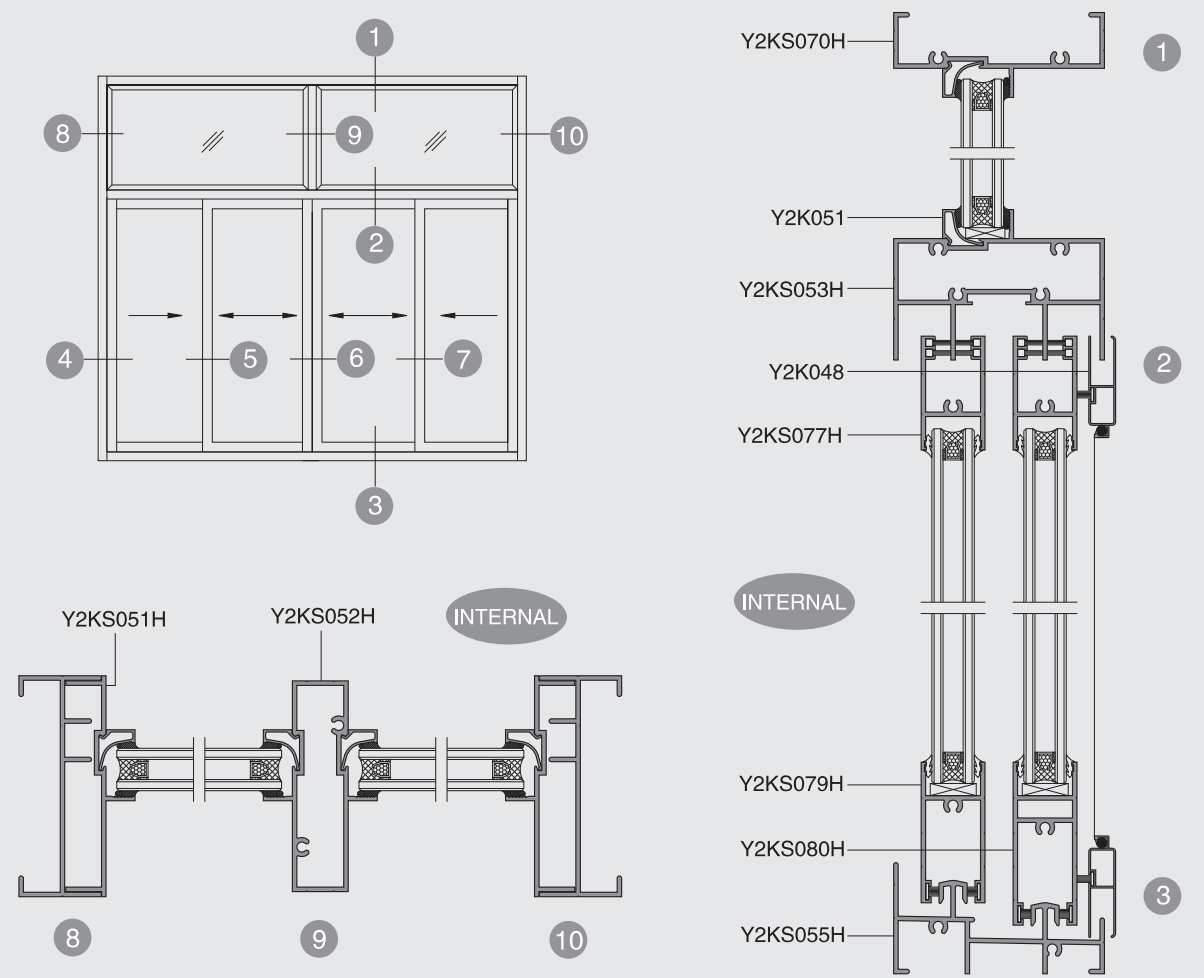



Y2KS System 3-track Sliding Door

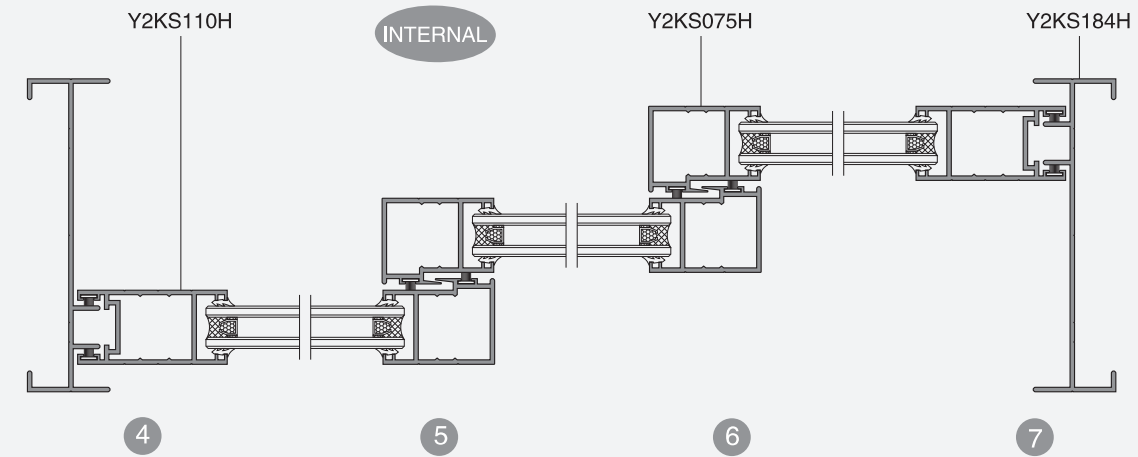
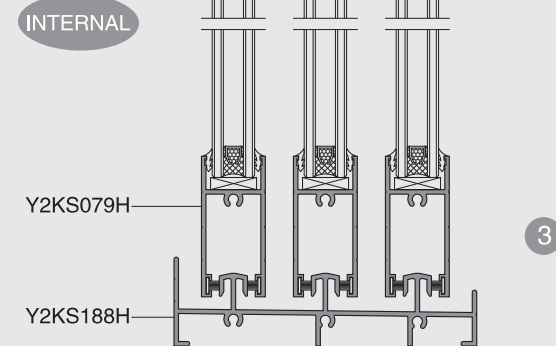
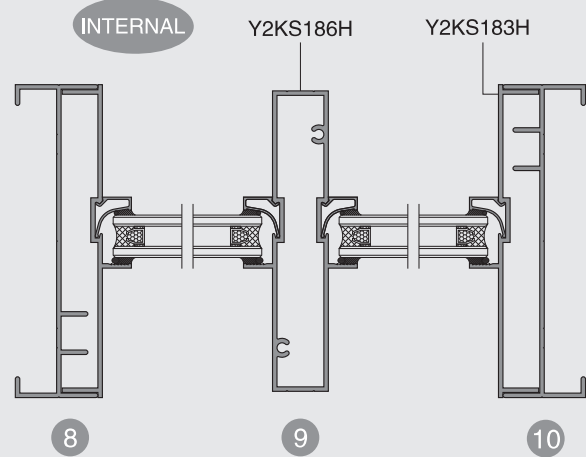
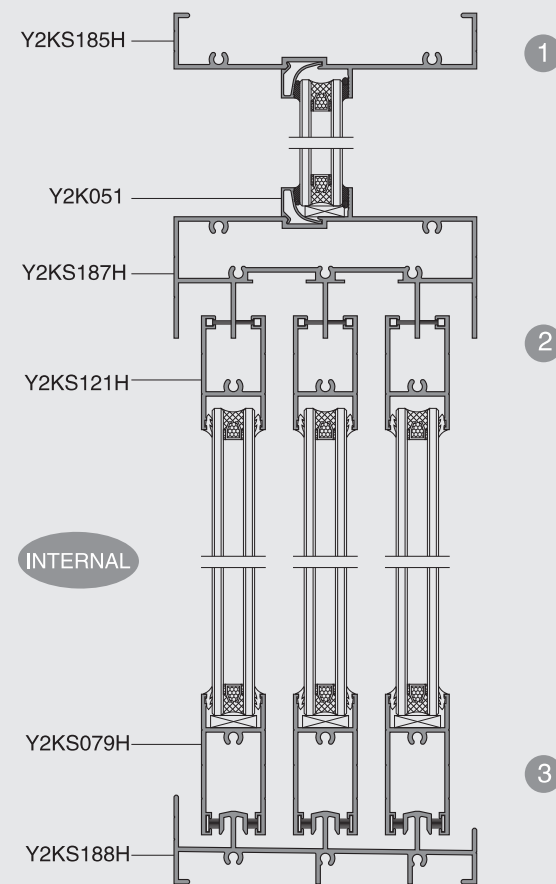
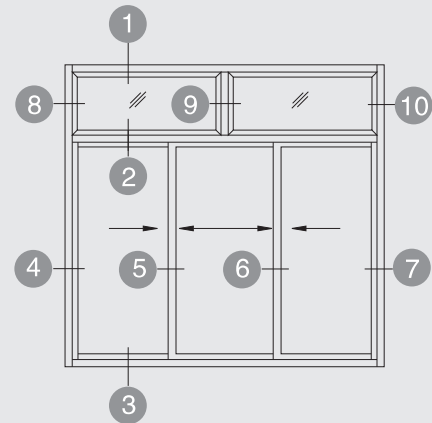

Y2KS System Single-track Sliding Door

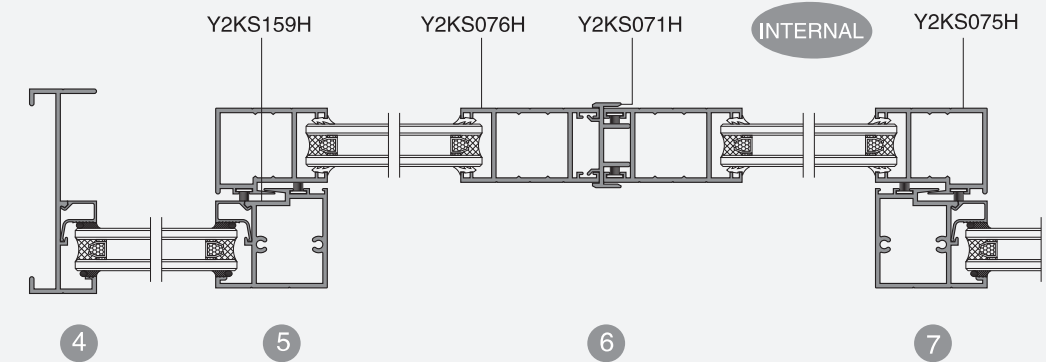
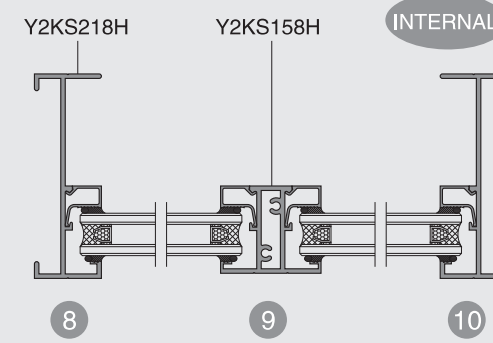
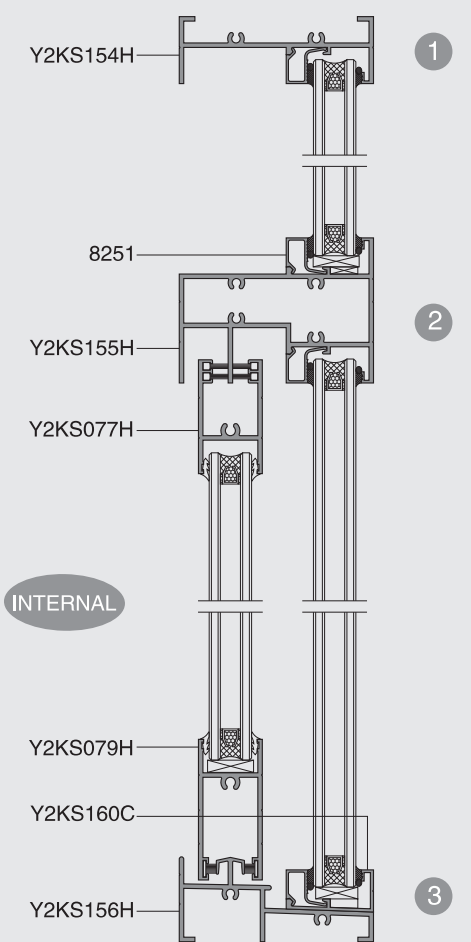
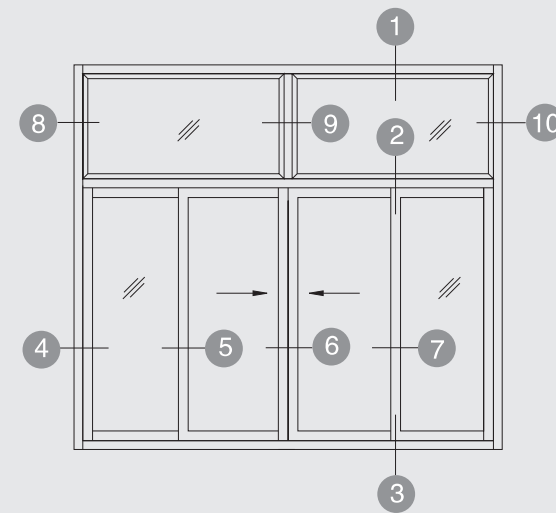



Application	Head	Application	Head	Application	Head	Application	Head
DWG No.	Y2KS054C	DWG No.	Y2KS054S	DWG No.	Y2KS054H	DWG No.	Y2KS105H
Thickness	δ =1.4	Thickness	δ =1.9	Thickness	δ =2.0	Thickness	δ =2.0
T.W.	1.006kg/m	T.W.	1.297kg/m	T.W.	1.356kg/m	T.W.	1.550kg/m

1

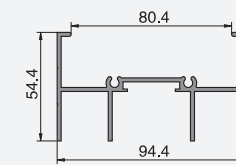
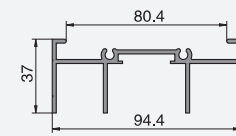
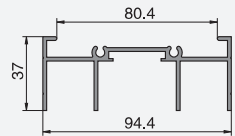
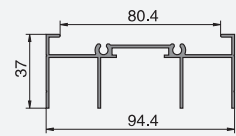

Application	Head	Application	Head	Application	Head	Application	Head
DWG No.	Y2KS235H	DWG No.	Y2KS231H	DWG No.	Y2KS053S	DWG No.	Y2KS053H
Thickness	δ =2.0	Thickness	δ =2.0	Thickness	δ =1.9	Thickness	δ =2.0
T.W.	1.464kg/m	T.W.	1.488kg/m	T.W.	2.102kg/m	T.W.	2.200kg/m

2

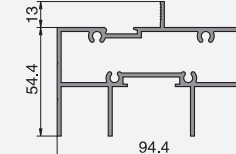
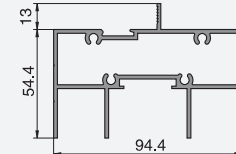
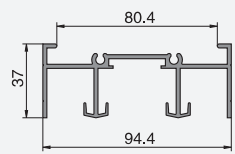
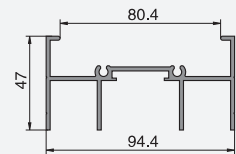

Application	Sill	Application	Sill	Application	Sill	Application	Sill
DWG No.	Y2KS056H	DWG No.	Y2KS055S	DWG No.	Y2KS055H	DWG No.	Y2KS111H
Thickness	δ =2.0	Thickness	δ =1.9	Thickness	δ =2.0	Thickness	δ =2.0
T.W.	1.471kg/m	T.W.	1.621kg/m	T.W.	1.698kg/m	T.W.	1.587kg/m

3

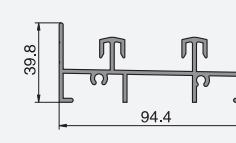
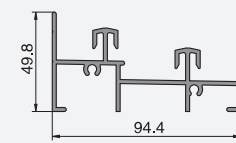
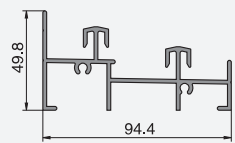
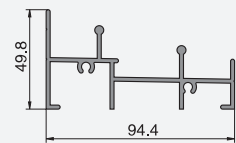

Application	Jamb	Application	Jamb	Application	Jamb	Application	Jamb
DWG No.	Y2KS050C	DWG No.	Y2KS050S	DWG No.	Y2KS050H	DWG No.	Y2KS234H
Thickness	δ =1.4	Thickness	δ =1.9	Thickness	δ =2.0	Thickness	δ =2.0
T.W.	0.799kg/m	T.W.	1.062kg/m	T.W.	1.117kg/m	T.W.	1.225kg/m

4

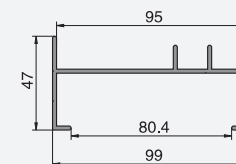
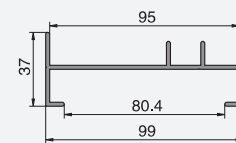
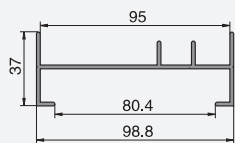
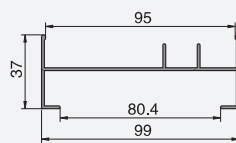

Application	Jamb	Application	Jamb reverse insert plate	Application	Jamb insert plate	Application	Jamb insert plate
DWG No.	Y2KS239H	DWG No.	Y2KS238H	DWG No.	Y2KS051S	DWG No.	Y2KS051H
Thickness	δ =2.0	Thickness	δ =2.0	Thickness	δ =1.9	Thickness	δ =2.0
T.W.	1.555kg/m	T.W.	0.682kg/m	T.W.	0.777kg/m	T.W.	0.814kg/m

5

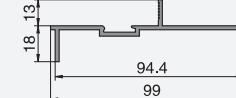
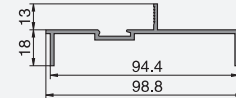
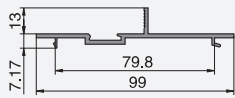
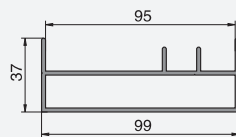

Application	Fixed Frame	Application	Fixed Frame	Application	Mullion	Application	Mullion
DWG No.	Y2KS070S	DWG No.	Y2KS070H	DWG No.	Y2KS052S	DWG No.	Y2KS052H
Thickness	δ =1.9	Thickness	δ =2.0	Thickness	δ =1.9	Thickness	δ =2.0
T.W.	0.983kg/m	T.W.	1.029kg/m	T.W.	1.502kg/m	T.W.	1.576kg/m

1

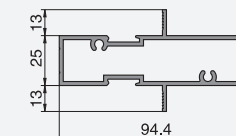
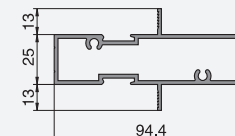
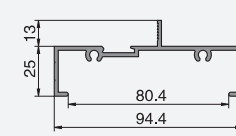
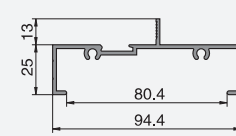

Application	Head	Application	Head	Application	Sill	Application	Sill
DWG No.	Y2KS284H	DWG No.	Y2KS187H	DWG No.	Y2KS188H	DWG No.	Y2KS285H
Thickness	δ =2.0	Thickness	δ =2.0	Thickness	δ =2.0	Thickness	δ =2.0
T.W.	1.671kg/m	T.W.	2.897kg/m	T.W.	2.072kg/m	T.W.	1.664kg/m

2

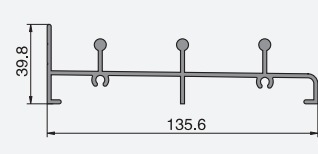
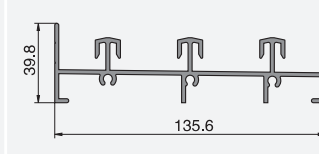
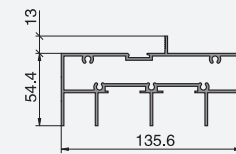
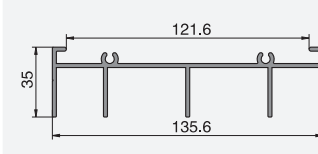

Application	Jamb	Application	Jamb insert plate	Application	Fixed Frame	Application	Mullion
DWG No.	Y2KS184H	DWG No.	Y2KS183H	DWG No.	Y2KS185H	DWG No.	Y2KS186H
Thickness	δ =2.0	Thickness	δ =2.0	Thickness	δ =2.0	Thickness	δ =2.0
T.W.	1.340kg/m	T.W.	1.041kg/m	T.W.	1.269kg/m	T.W.	2.028kg/m

3

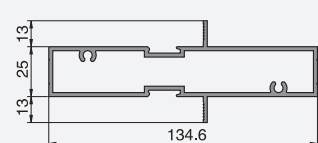
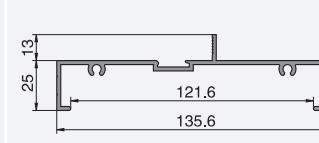
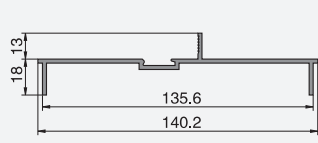
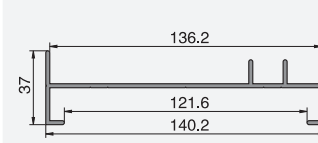

Application	Single Top Rail	Application	Single Top Rail	Application	Single Top Rail	Application	Single Bottom Rail
DWG No.	Y2KS057T	DWG No.	Y2KS133T	DWG No.	Y2KS057H	DWG No.	Y2KS068H
Thickness	δ =1.8	Thickness	δ =1.9	Thickness	δ =2.0	Thickness	δ =2.0
T.W.	0.885kg/m	T.W.	0.792kg/m	T.W.	0.940kg/m	T.W.	1.069kg/m

4

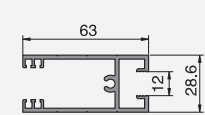
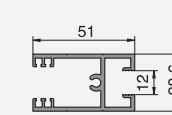
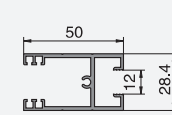
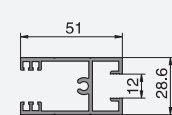

Application	Single Bottom Rail	Application	Single Bottom Rail	Application	Single Bottom Rail	Application	sill for out-side glazing
DWG No.	Y2KS066T	DWG No.	Y2KS132T	DWG No.	Y2KS066H	DWG No.	Y2KS069H
Thickness	δ =1.8	Thickness	δ =1.9	Thickness	δ =2.0	Thickness	δ =2.0
T.W.	0.953kg/m	T.W.	0.880kg/m	T.W.	1.022kg/m	T.W.	1.310kg/m

5

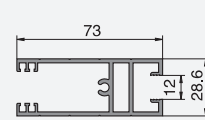
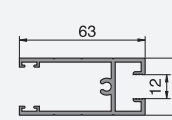
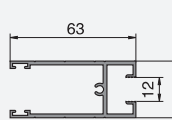
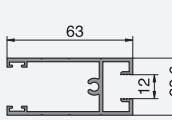



Application	sill for out-side glazing	Application	sill for out-side glazing	Application	Single Stile	Application	Single Stile
DWG No.	Y2KS134T	DWG No.	Y2KS067H	DWG No.	Y2KS059T	DWG No.	Y2KS130T
Thickness	δ =1.9	Thickness	δ =2.0	Thickness	δ =1.8	Thickness	δ =1.9
T.W.	1.110kg/m	T.W.	1.263kg/m	T.W.	1.049kg/m	T.W.	1.075kg/m

1

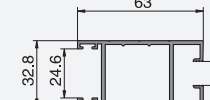
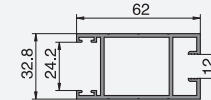
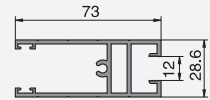
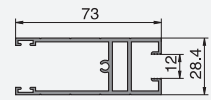

Application	Single Stile	Application	Single Stile	Application	Single Stile	Application	Single Interlock
DWG No.	Y2KS059H	DWG No.	Y2KS149H	DWG No.	Y2KS065H	DWG No.	Y2KS058T
Thickness	δ =2.0	Thickness	δ =2.0	Thickness	δ =2.0	Thickness	δ =1.8
T.W.	1.165kg/m	T.W.	1.588kg/m	T.W.	1.295kg/m	T.W.	0.976kg/m

2

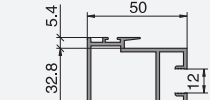
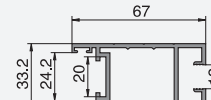
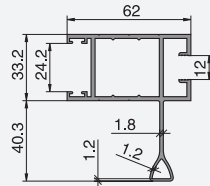
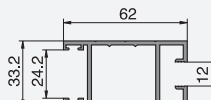

Application	Single Interlock	Application	Single Interlock	Application	Single Hav. Interlock	Application	Double Top Rail
DWG No.	Y2KS131T	DWG No.	Y2KS058H	DWG No.	Y2KS084H	DWG No.	Y2KS077S
Thickness	δ =1.9	Thickness	δ =2.0	Thickness	δ =2.0	Thickness	δ =1.9
T.W.	1.017kg/m	T.W.	1.079kg/m	T.W.	1.656kg/m	T.W.	0.808kg/m

3

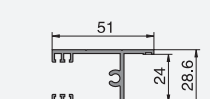
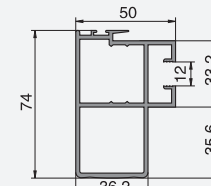
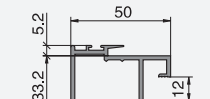
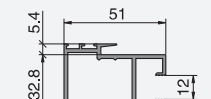

Application	Double Top Rail	Application	Double Top Rail	Application	Double Top Rail	Application	Double Bottom Rail
DWG No.	Y2KS121H	DWG No.	Y2KS077H	DWG No.	Y2KS232H	DWG No.	Y2KS081H
Thickness	δ =2.0	Thickness	δ =2.0	Thickness	δ =2.0	Thickness	δ =2.0
T.W.	0.806kg/m	T.W.	0.840kg/m	T.W.	0.781kg/m	T.W.	0.969kg/m

4

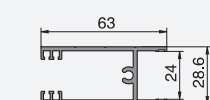
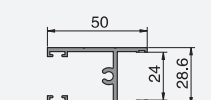
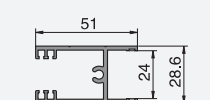
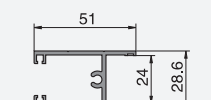

Application	Double Bottom Rail	Application	Double Bottom Rail	Application	sill for out-side glazing	Application	sill for out-side glazing
DWG No.	Y2KS079S	DWG No.	Y2KS079H	DWG No.	Y2KS082H	DWG No.	Y2KS080S
Thickness	δ =1.9	Thickness	δ =2.0	Thickness	δ =2.0	Thickness	δ =1.9
T.W.	0.883kg/m	T.W.	0.921kg/m	T.W.	1.210kg/m	T.W.	1.113kg/m

5

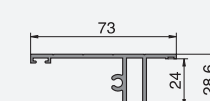
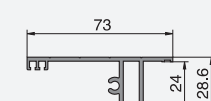
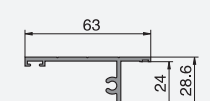
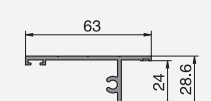

Application	sill for out-side glazing	Application	Double Bottom Rail	Application	sill for out-side glazing	Application	Double Stile
DWG No.	Y2KS080H	DWG No.	Y2KS102T	DWG No.	Y2KS103T	DWG No.	Y2KS076S
Thickness	δ =2.0	Thickness	δ =1.9	Thickness	δ =1.9	Thickness	δ =1.9
T.W.	1.162kg/m	T.W.	1.046kg/m	T.W.	1.149kg/m	T.W.	1.028kg/m

1

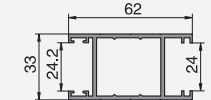
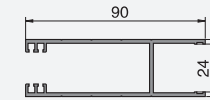
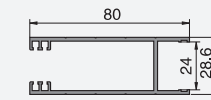
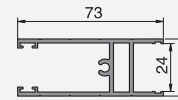

Application	Double Stile	Application	Double Stile	Application	Double Hav. Stile	Application	Double Hav. Stile
DWG No.	Y2KS076H	DWG No.	Y2KS110H	DWG No.	Y2KS196H	DWG No.	Y2KS226H
Thickness	δ =2.0	Thickness	δ =2.0	Thickness	δ =2.0	Thickness	δ =2.0
T.W.	1.078kg/m	T.W.	1.208kg/m	T.W.	1.631kg/m	T.W.	1.818kg/m

2

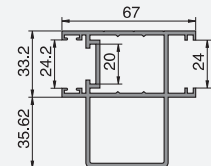
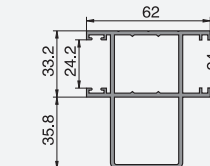
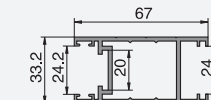
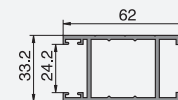

Application	Double Hav. Stile	Application	Double Interlock	Application	Double Interlock	Application	Double Interlock
DWG No.	Y2KS115H	DWG No.	Y2KS075S	DWG No.	Y2KS075H	DWG No.	Y2KS075H-A
Thickness	δ =2.0	Thickness	δ =1.9	Thickness	δ =2.0	Thickness	δ =2.0
T.W.	1.437kg/m	T.W.	0.948kg/m	T.W.	0.992kg/m	T.W.	0.999kg/m

3

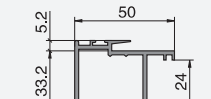
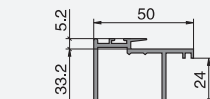
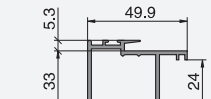
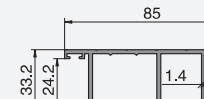

Application	Double Hav. Interlock	Application	Double Hav. Interlock	Application	Double Hav. Interlock	Application	Stile Adapter
DWG No.	Y2KS116H	DWG No.	Y2KS101H	DWG No.	Y2KS101H-A	DWG No.	Y2KS071S
Thickness	δ =2.0	Thickness	δ =2.0	Thickness	δ =2.0	Thickness	δ =1.9
T.W.	1.498kg/m	T.W.	1.569kg/m	T.W.	1.576kg/m	T.W.	0.447kg/m

4

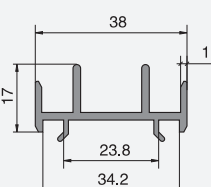
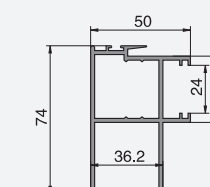
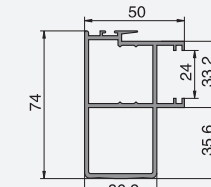
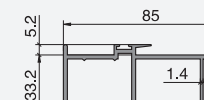

Application	Stile Adapter	Application	90° Corner Post	Application	Double Top Rail	Application	Double Bottom Rail
DWG No.	Y2KS071H	DWG No.	Y2KS021H	DWG No.	G9006H	DWG No.	G9007H
Thickness	δ =2.0	Thickness	δ =2.0	Thickness	δ =2.0	Thickness	δ =2.0
T.W.	0.465kg/m	T.W.	2.029kg/m	T.W.	0.783kg/m	T.W.	0.906kg/m

5

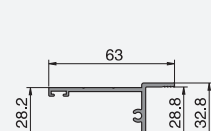
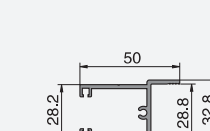
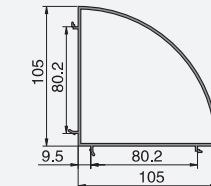
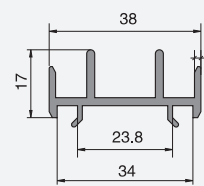



Application	Double Stile	Application	Double Interlock	Application	Transom	Application	Double Bead
DWG No.	G9010H	DWG No.	G9009H	DWG No.	G9008H	DWG No.	Y2KS233
Thickness	δ =2.0	Thickness	δ =2.0	Thickness	δ =2.0	Thickness	δ =1.0
T.W.	1.136kg/m	T.W.	0.954kg/m	T.W.	1.227kg/m	T.W.	0.186kg/m

1

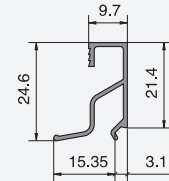
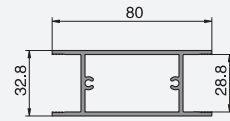
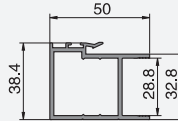
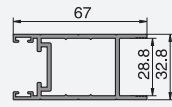

Application	Head	Application	Head	Application	Head	Application	Sill
DWG No.	Y2KS161H	DWG No.	Y2KS230H	DWG No.	Y2KS155H	DWG No.	Y2KS156H
Thickness	δ =2.0	Thickness	δ =2.0	Thickness	δ =2.0	Thickness	δ =2.0
T.W.	1.221kg/m	T.W.	1.237kg/m	T.W.	2.013kg/m	T.W.	1.151kg/m

2

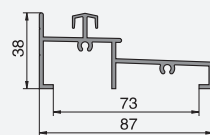
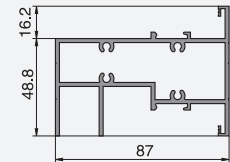
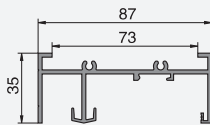
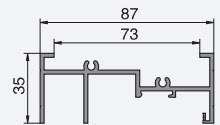

Application	Sill	Application	Jamb	Application	Jamb	Application	Fixed Frame
DWG No.	Y2KS205H	DWG No.	Y2KS157H	DWG No.	Y2KS218H	DWG No.	Y2KS154H
Thickness	δ =2.0	Thickness	δ =2.0	Thickness	δ =2.0	Thickness	δ =2.0
T.W.	1.201kg/m	T.W.	1.068kg/m	T.W.	0.935kg/m	T.W.	0.990kg/m

3

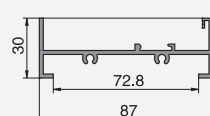
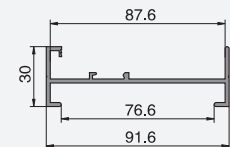
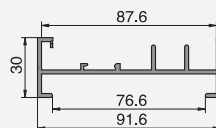
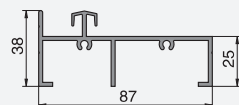

Application	Mullion	Application	fixing interlock	Application	adaptor	Application	adaptor
DWG No.	Y2KS158H	DWG No.	Y2KS159H	DWG No.	Y2KS160C	DWG No.	Y2K110S
Thickness	δ =2.0	Thickness	δ =2.0	Thickness	δ =1.4	Thickness	δ =1.2
T.W.	0.916kg/m	T.W.	1.108kg/m	T.W.	0.280kg/m	T.W.	0.283kg/m

4

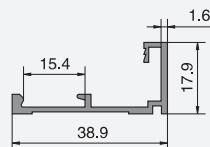
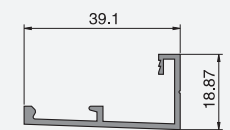
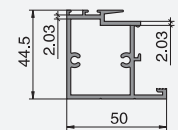
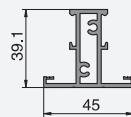

Application	Single Bead	Application	Single Bead	Application	Single Bead	Application	Double Bead
DWG No.	3806	DWG No.	Y2K010	DWG No.	Y2K044	DWG No.	8251
Thickness	δ =1.0	Thickness	δ =1.0	Thickness	δ =1.0	Thickness	δ =1.0
T.W.	0.145kg/m	T.W.	0.169kg/m	T.W.	0.130kg/m	T.W.	0.141kg/m

5

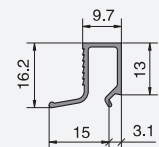
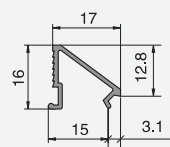
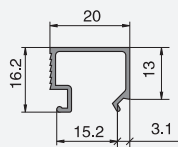
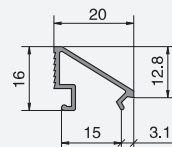

Application	Double Bead	Application	Double Bead	Application	Double Bead	Application	Double Bead
DWG No.	82189	DWG No.	EA4008	DWG No.	Y2K051	DWG No.	38117
Thickness	δ =0.9	Thickness	δ =0.9	Thickness	δ =1.0	Thickness	δ =1.0
T.W.	0.129kg/m	T.W.	0.116kg/m	T.W.	0.127kg/m	T.W.	0.129kg/m

1

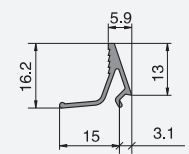
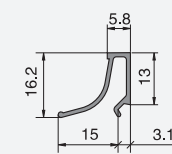
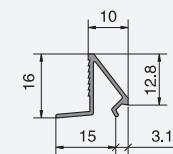
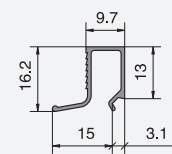

Application	Double Bead	Application	Screens	Application	Screens	Application	Screens
DWG No.	Y2KS263	DWG No.	Y2K048	DWG No.	QDS7614	DWG No.	A7242
Thickness	δ =0.7	Thickness	δ =0.8	Thickness	δ =0.8	Thickness	δ =0.9
T.W.	0.095kg/m	T.W.	0.256kg/m	T.W.	0.287kg/m	T.W.	0.318kg/m

2

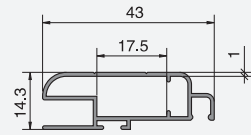
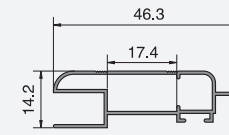
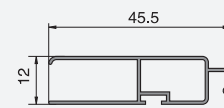
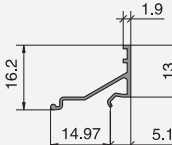

Application	Screens	Application	Screens	Application	—	Application	—
DWG No.	208114	DWG No.	QD76165M	DWG No.	QD76166M	DWG No.	Y2KS220M
Thickness	δ =0.9	Thickness	δ =1.0	Thickness	δ =1.0	Thickness	δ =1.0
T.W.	0.326kg/m	T.W.	0.432kg/m	T.W.	0.511kg/m	T.W.	0.494kg/m

3

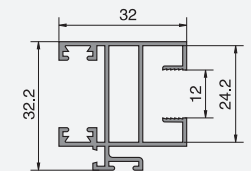
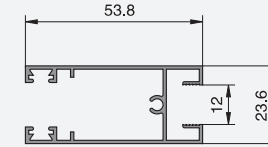
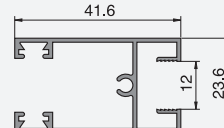
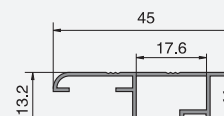

Application	—	Application	—	Application	—	Application	—
DWG No.	—	DWG No.	Y2KS219C	DWG No.	—	DWG No.	QD7617C
Thickness	—	Thickness	δ =1.4	Thickness	—	Thickness	δ =1.4
T.W.	—	T.W.	0.284kg/m	T.W.	—	T.W.	0.277kg/m

4

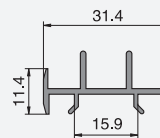
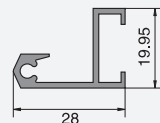



Y2KS(91) System Sliding Window

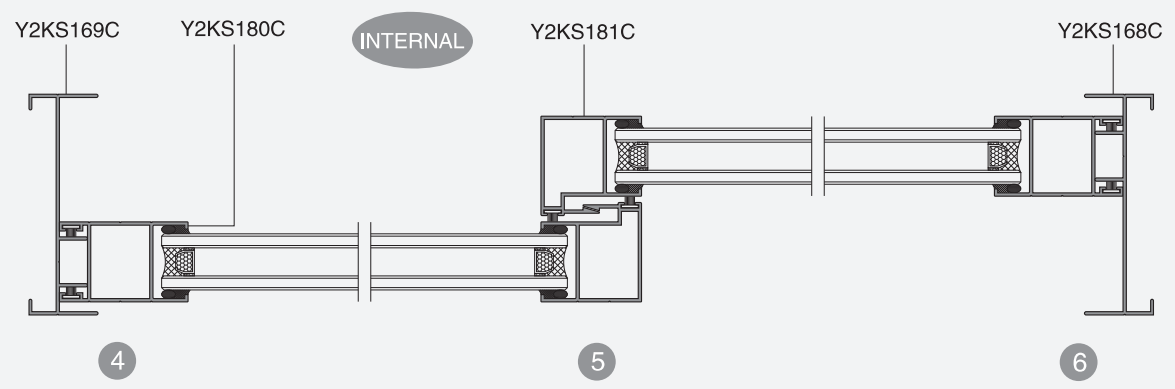
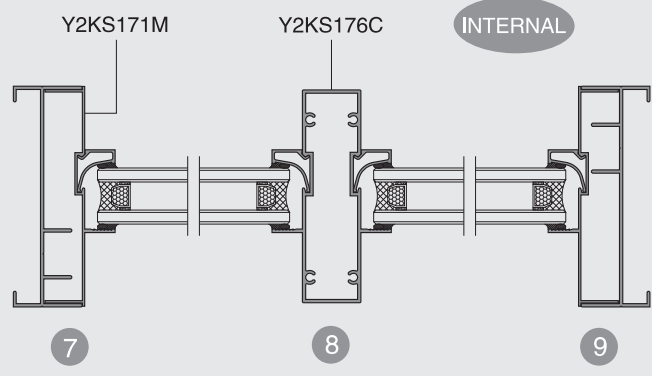
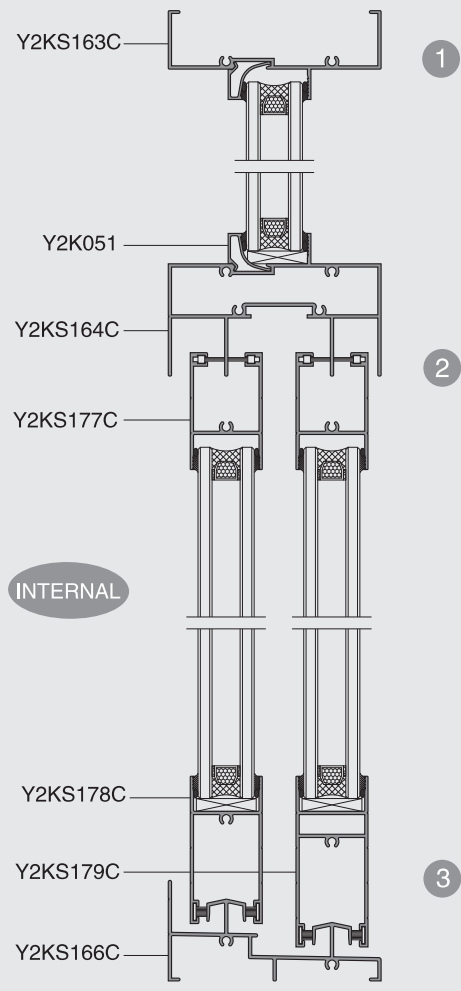
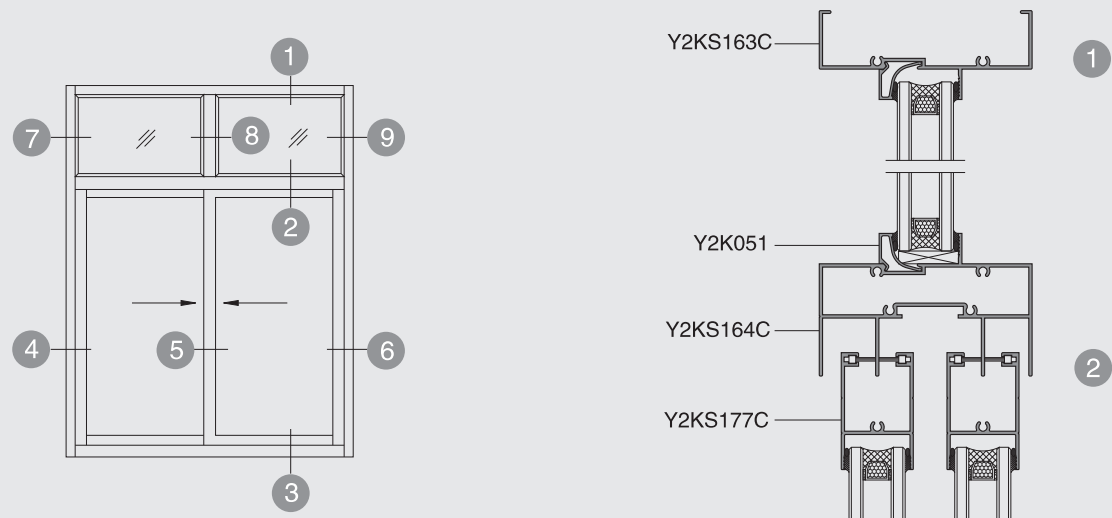

Application	Head	Application	Head	Application	Sill	Application	Sill
DWG No.	Y2KS165C	DWG No.	Y2KS164C	DWG No.	Y2KS166C	DWG No.	Y2KS167C
Thickness	δ = 1.4	Thickness	δ = 1.4	Thickness	δ = 1.4	Thickness	δ = 1.4
T.W.	0.895kg/m	T.W.	1.435kg/m	T.W.	1.002kg/m	T.W.	1.414kg/m
Application	Jamb	Application	Jamb	Application	Jamb insert plate	Application	reverse insert plate
DWG No.	Y2KS168C	DWG No.	Y2KS169C	DWG No.	Y2KS171M	DWG No.	Y2KS170M
Thickness	δ = 1.4	Thickness	δ = 1.4	Thickness	δ = 1.0	Thickness	δ = 1.0
T.W.	0.693kg/m	T.W.	0.693kg/m	T.W.	0.414kg/m	T.W.	0.358kg/m
Application	Fixed Frame	Application	Mullion	Application	Double Top Rail	Application	Double Bottom Rail
DWG No.	Y2KS163C	DWG No.	Y2KS176C	DWG No.	Y2KS177C	DWG No.	Y2KS178C
Thickness	δ = 1.4	Thickness	δ = 1.4	Thickness	δ = 1.4	Thickness	δ = 1.4
T.W.	0.675kg/m	T.W.	1.133kg/m	T.W.	0.599kg/m	T.W.	0.644kg/m
Application	sill for out-side glazing	Application	Double Stile	Application	Double Interlock	Application	Stile Adapter
DWG No.	Y2KS179C	DWG No.	Y2KS180C	DWG No.	Y2KS181C	DWG No.	Y2KS195
Thickness	δ = 1.4	Thickness	δ = 1.4	Thickness	δ = 1.4	Thickness	δ = 1.4
T.W.	0.825kg/m	T.W.	0.715kg/m	T.W.	0.704kg/m	T.W.	0.355kg/m
Application	Double Bead	Application	Connector	Application	90° Corner Post	Application	90° Corner Post
DWG No.	Y2K051	DWG No.	Y2KS175C	DWG No.	Y2KS173S	DWG No.	Y2KS174S
Thickness	δ = 1.0	Thickness	δ = 1.4	Thickness	δ = 1.4	Thickness	δ = 1.4
T.W.	0.127kg/m	T.W.	0.468kg/m	T.W.	1.390kg/m	T.W.	1.527kg/m



Application	90° Corner Post		
DWG No.	Y2KS194S		
Thickness	δ = 1.4		
T.W.	1.527kg/m		

1

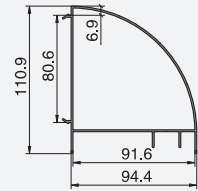

GRPK55 System Thermal Break in-opening & Horizontal Pivoting Window

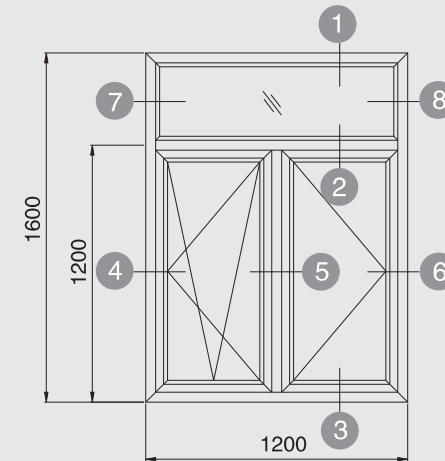

Window area	1.92 m ²
Unit weight	10.57 kg/m ²

INTERNAL

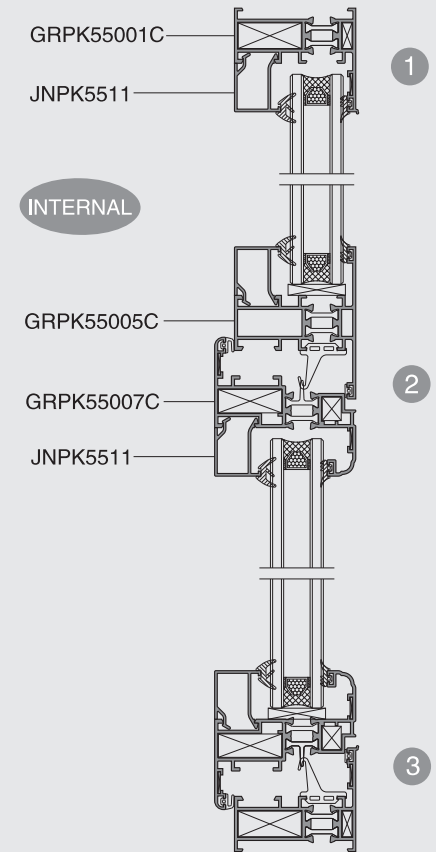
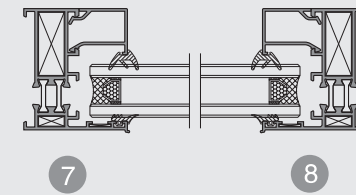

INTERNAL

GRPK55008C

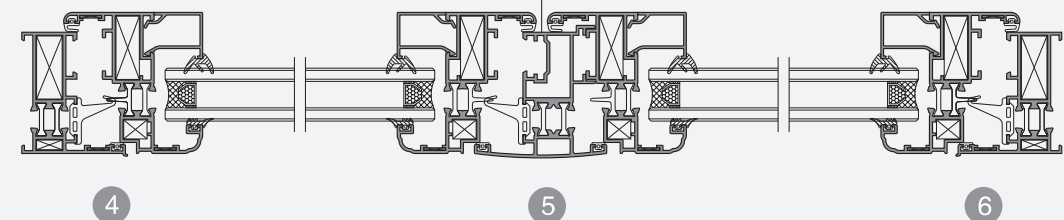



GUANG YA

GRPK55 System Thermal Break in-opening Casement Window (with outer Flyscreen)



GUANG YA

GRPK55 System Thermal Break in-opening Casement Window (with outer fixed Flyscreen)

GRPK55 System Thermal Break in-opening Casement Window (with outer Flyscreen)

GRPK55 System Thermal Break in-opening Casement Window (with outer fixed Flyscreen)

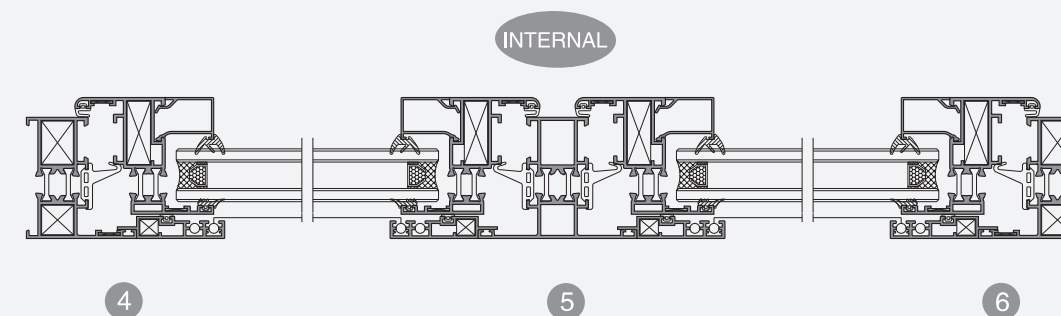
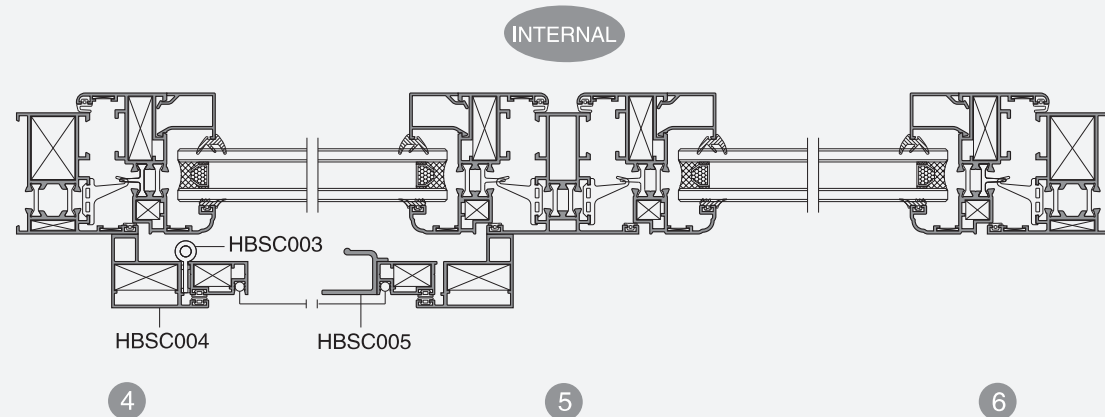
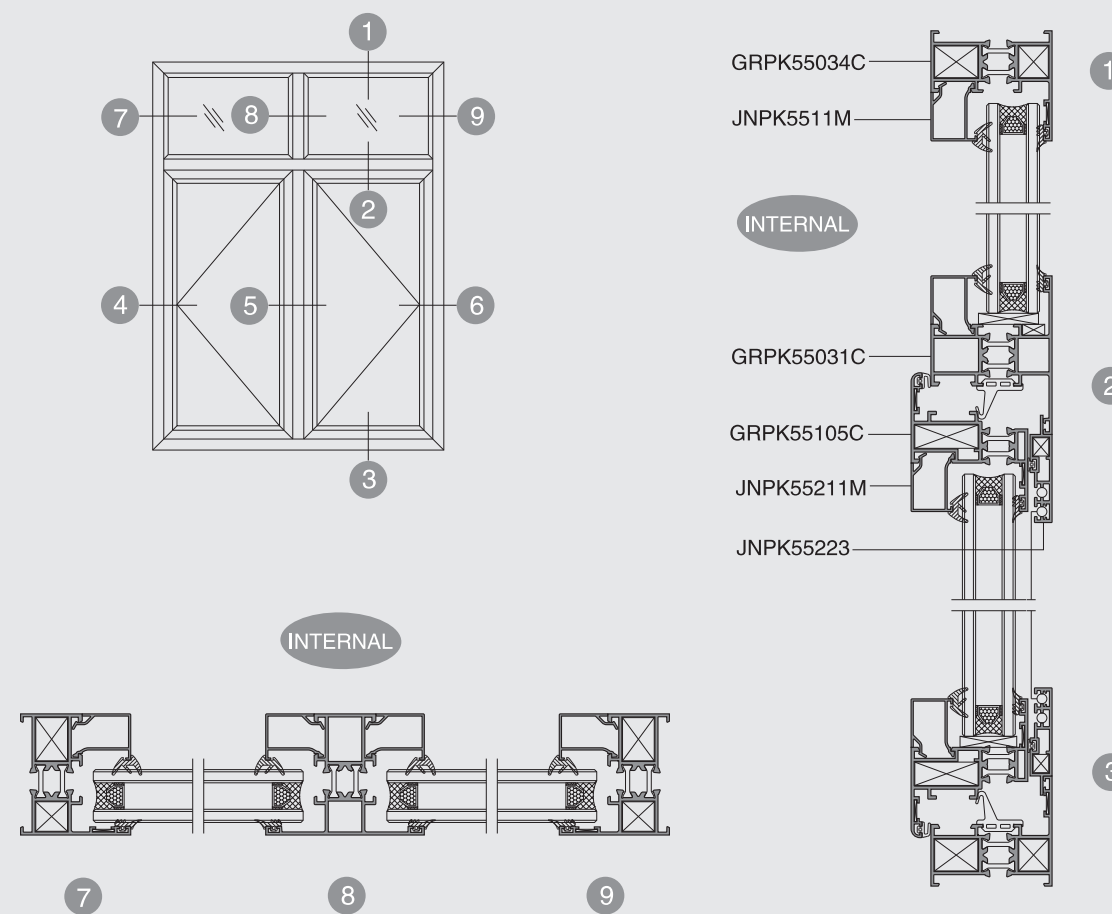
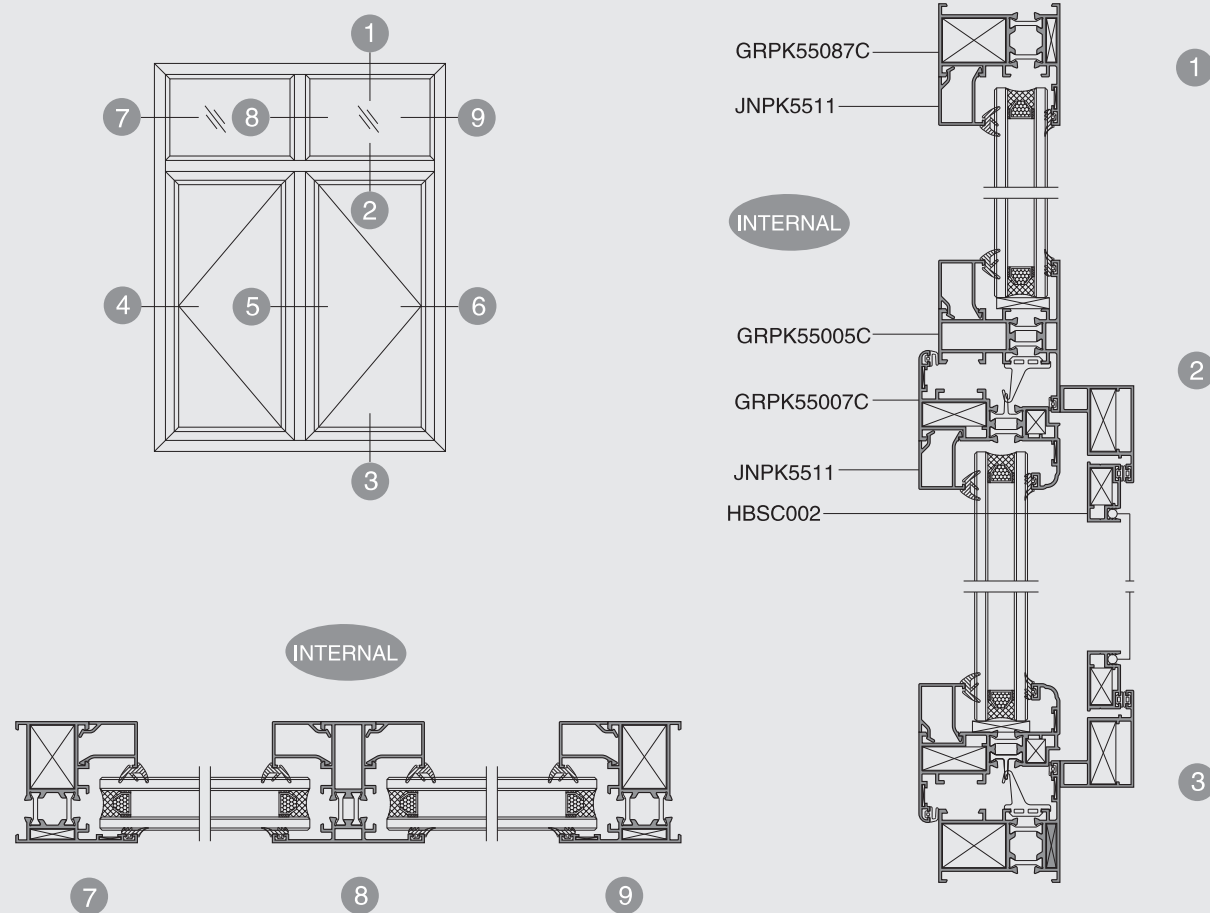



GRPK55 System Thermal Break out-opening Casement Window

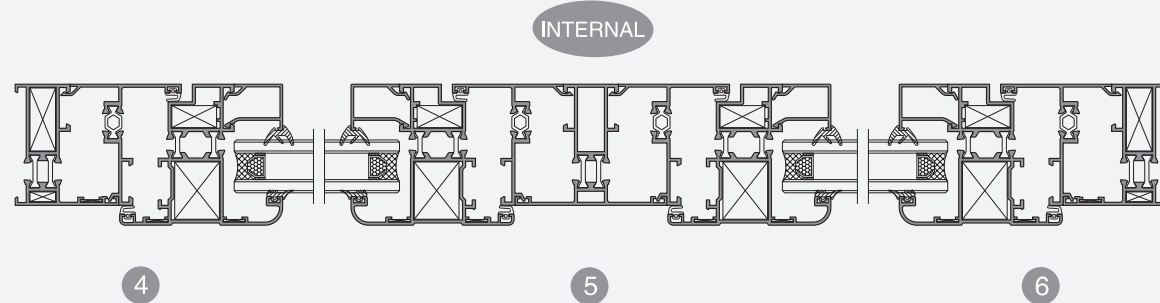
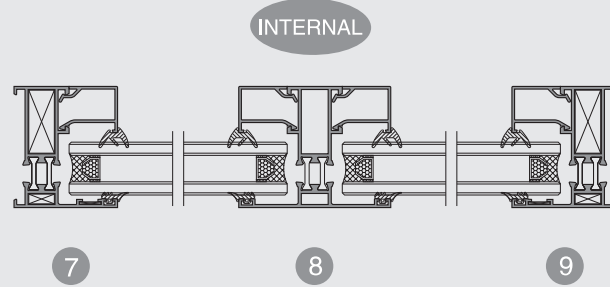
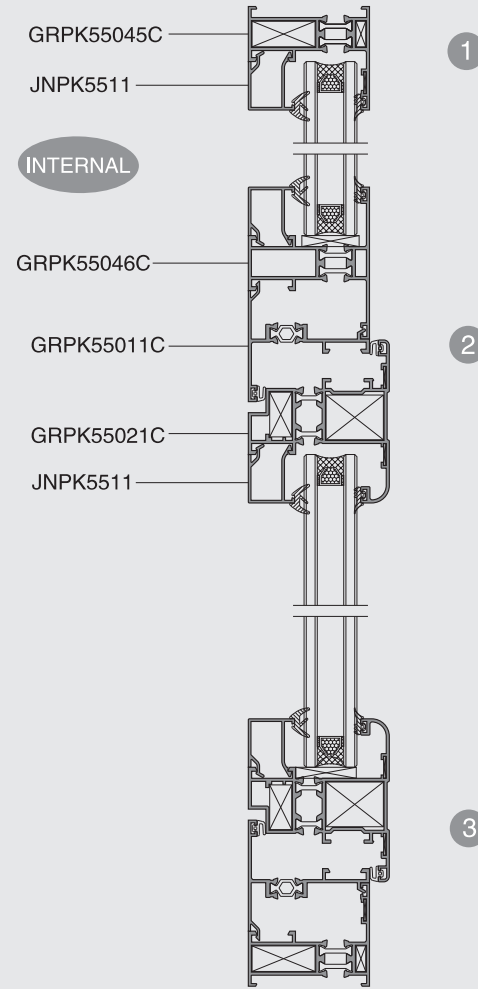
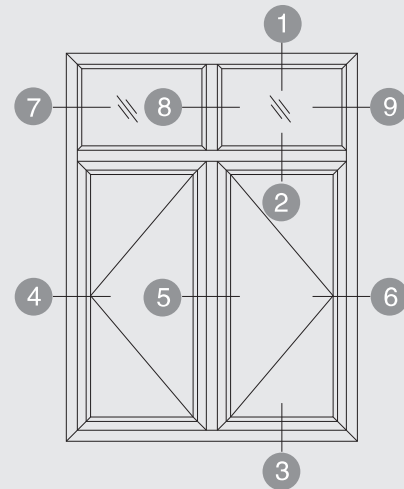

Application	Frame	Application	Frame	Application	Frame	Application	Frame
DWG No.	GRPK55001C	DWG No.	GRPK55004C	DWG No.	GRPK55028C	DWG No.	GRPK55087C
Thickness	$\delta = 1.4$	Thickness	$\delta = 1.4$	Thickness	$\delta = 1.4$	Thickness	$\delta = 1.4$
T.W.	1.021kg/m	T.W.	1.071kg/m	T.W.	1.172kg/m	T.W.	1.168kg/m
Corner joint	5015	Corner joint	5015	Corner joint	GJ6014	Corner joint	GJ6014
Cross joint	JNPK5513	Cross joint	JNPK5513	Cross joint	JNPK5513	Cross joint	JNPK5513
Application	Frame	Application	Out-opening Frame	Application	Out-opening Frame	Application	Mullion
DWG No.	GRPK55003C	DWG No.	GRPK55086C	DWG No.	GRPK55045C	DWG No.	GRPK55005C
Thickness	$\delta = 1.4$	Thickness	$\delta = 1.4$	Thickness	$\delta = 1.4$	Thickness	$\delta = 1.4$
T.W.	1.071kg/m	T.W.	0.969kg/m	T.W.	0.969kg/m	T.W.	1.180kg/m
Corner joint	5015	Corner joint	5015	Corner joint	5015	Corner joint	5015
Cross joint	JNPK5520	Cross joint	JNPK5520	Cross joint	JNPK5513	Cross joint	JNPK5513
Application	Mullion	Application	Mullion	Application	Out-opening Mullion	Application	Hav. Mullion
DWG No.	GRPK55029C	DWG No.	GRPK55012C	DWG No.	GRPK55009C	DWG No.	GRPK55019C
Thickness	$\delta = 1.4$	Thickness	$\delta = 1.4$	Thickness	$\delta = 1.4$	Thickness	$\delta = 1.4$
T.W.	1.295kg/m	T.W.	1.173kg/m	T.W.	1.079kg/m	T.W.	1.579kg/m
Corner joint	5015	Corner joint	5015	Corner joint	5015	Corner joint	5015
Cross joint	JNPK5513	Cross joint	JNPK5513	Cross joint	JNPK5520	Cross joint	JNPK5513
Application	Out-opening Mullion	Application	Out-opening Mullion	Application	Hav. Mullion		
DWG No.	GRPK55108C	DWG No.	GRPK55046C	DWG No.	GRPK55077C		
Thickness	$\delta = 1.4$	Thickness	$\delta = 1.4$	Thickness	$\delta = 1.4$		
T.W.	1.151kg/m	T.W.	1.084kg/m	T.W.	1.429kg/m		
Corner joint	5015	Corner joint	5015	Corner joint	5015		
Cross joint	JNPK5513	Cross joint	JNPK5513	Cross joint	JNPK5513		



Application	Out-opening Hav. Mullion	Application	Hav. Mullion	Application	Frame	Application	Frame
DWG No.	GRPK55036C	DWG No.	GRPK55070C	DWG No.	GRPK55030C	DWG No.	GRPK55034C
Thickness	δ = 1.4	Thickness	δ = 1.4	Thickness	δ = 1.4	Thickness	δ = 1.4
T.W.	1.530kg/m	T.W.	1.649kg/m	T.W.	1.069kg/m	T.W.	1.065kg/m
Corner joint	=====	Corner joint	=====	Corner joint	JN6402	Corner joint	JN6402
Cross joint	JNPK5520	Cross joint	=====	Cross joint	JN60C92 JNPK55180	Cross joint	JN60C92 JNPK55180

1

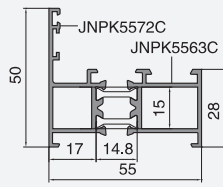
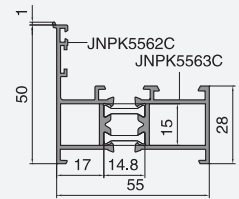
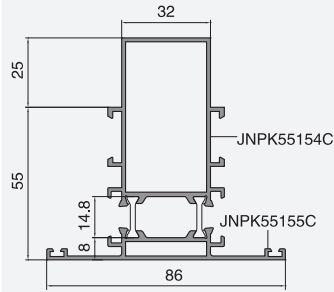
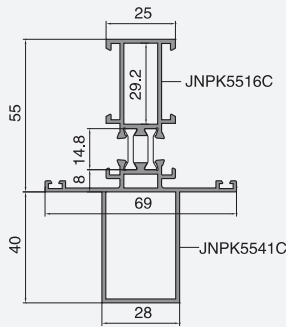

Application	Frame	Application	Frame
DWG No.	GRPK55054C	DWG No.	GRPK55106C
Thickness	δ = 1.4	Thickness	δ = 1.4
T.W.	1.086kg/m	T.W.	1.162kg/m
Corner joint	JN6402	Corner joint	JNPK65B119
Cross joint	JN60C92 JNPK55180	Cross joint	JN60C92 JNPK55180

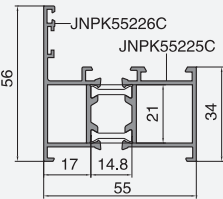
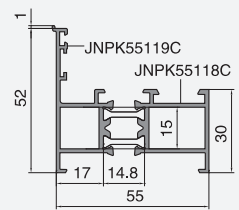

2

Application	Frame	Application	Frame	Application	Frame	Application	Frame
DWG No.	GRPK55110C	DWG No.	GRPK55073C	DWG No.	GRPK55109C	DWG No.	GRPK55103C
Thickness	δ = 1.4	Thickness	δ = 1.4	Thickness	δ = 1.4	Thickness	δ = 1.4
T.W.	1.114kg/m	T.W.	1.168kg/m	T.W.	1.151kg/m	T.W.	0.840kg/m
Corner joint	JN6402	Corner joint	JNJY5223	Corner joint	JN6402	Corner joint	=====
Cross joint	JN60C92 JNPK55180	Cross joint	JN60C92 JNPK55180	Cross joint	JN60C92 JNPK55180	Cross joint	=====

3

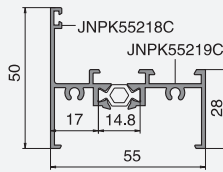
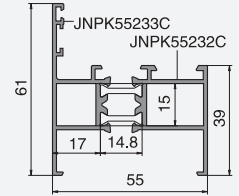
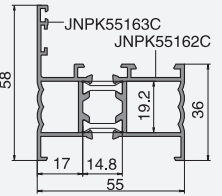
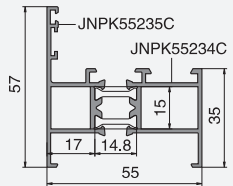

Application	Frame	Application	Mullion	Application	Mullion	Application	Mullion
DWG No.	GRPK55104C	DWG No.	GRPK55018C	DWG No.	GRPK55031C	DWG No.	GRPK55112C
Thickness	δ = 1.4	Thickness	δ = 1.4	Thickness	δ = 1.4	Thickness	δ = 1.4
T.W.	0.773kg/m	T.W.	1.094kg/m	T.W.	1.213kg/m	T.W.	1.246kg/m
Corner joint	=====	Corner joint	=====	Corner joint	=====	Corner joint	=====
Cross joint	=====	Cross joint	=====	Cross joint	JN60C92 JNPK55180	Cross joint	JN60C92 JNPK55180

4

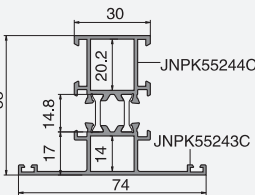
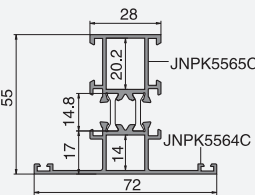
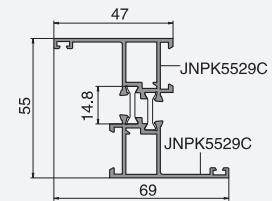
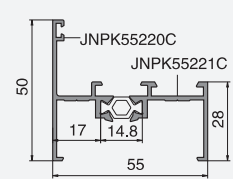

Application	Mullion	Application	Mullion	Application	Mullion	Application	Hav. Mullion
DWG No.	GRPK55116C	DWG No.	GRPK55084C	DWG No.	GRPK55067C	DWG No.	GRPK55062C
Thickness	δ = 1.4	Thickness	δ = 1.4	Thickness	δ = 1.4	Thickness	δ = 1.4
T.W.	1.290kg/m	T.W.	1.339kg/m	T.W.	1.666kg/m	T.W.	1.462kg/m
Corner joint	=====	Corner joint	=====	Corner joint	=====	Corner joint	=====
Cross joint	=====	Cross joint	=====	Cross joint	JN60C92 JNPK55180	Cross joint	JN60C92 JNPK55180

1

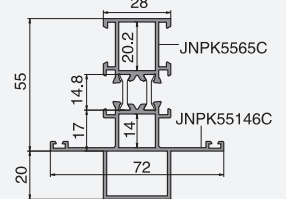
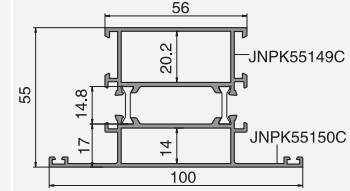
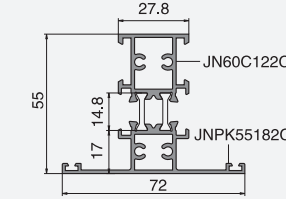
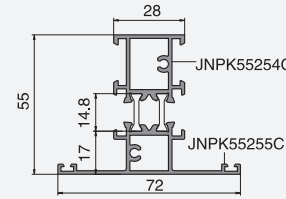

Application	Hav. Mullion	Application	Hav. Mullion	Application	Hav. Mullion	Application	Hav. Mullion
DWG No.	GRPK55117C	DWG No.	GRPK55032C	DWG No.	GRPK55111C	DWG No.	GRPK55113
Thickness	δ = 1.4	Thickness	δ = 1.4	Thickness	δ = 1.4	Thickness	δ = 1.4
T.W.	1.537kg/m	T.W.	1.612kg/m	T.W.	1.737kg/m	T.W.	2.385kg/m
Corner joint	=====	Corner joint	=====	Corner joint	=====	Corner joint	=====
Cross joint	=====	Cross joint	JN60C92 JNPK55180	Cross joint	=====	Cross joint	=====

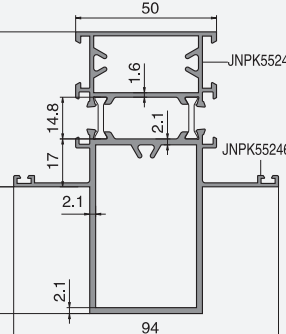
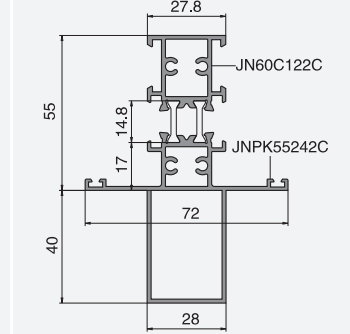
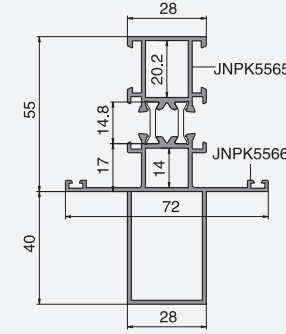
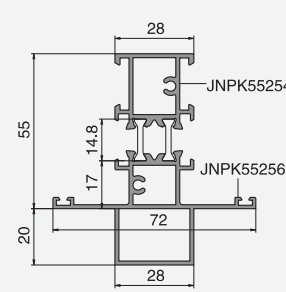

2

Application	Connector	Application	Connector	Application	Connector	Application	Connector
DWG No.	GRPK55011C	DWG No.	GRPK55010C	DWG No.	GRPK55079C	DWG No.	GRPK55081C
Thickness	δ = 1.4	Thickness	δ = 1.4	Thickness	δ = 1.4	Thickness	δ = 1.4
T.W.	0.667kg/m	T.W.	0.667kg/m	T.W.	1.020kg/m	T.W.	0.983kg/m
Corner joint	=====	Corner joint	=====	Corner joint	JN6402	Corner joint	JN6402
Cross joint	=====	Cross joint	=====	Cross joint	=====	Cross joint	=====

3

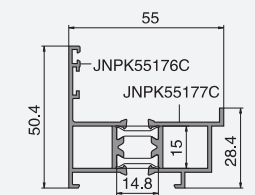
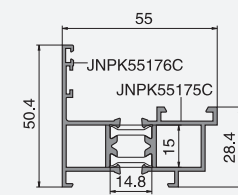
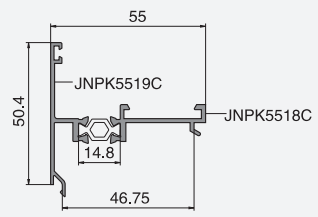
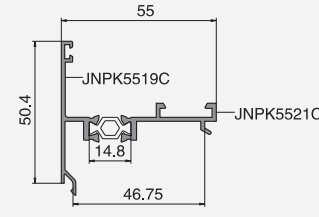



Application	Angle	Application	Angle	Application	Angle	Application	Angle
DWG No.	5015	DWG No.	JN6402	DWG No.	CG5066	DWG No.	JNJY5223
Thickness	—	Thickness	—	Thickness	δ = 3.0	Thickness	δ = 3.0
T.W.	2.226kg/m	T.W.	2.988kg/m	T.W.	2.297kg/m	T.W.	2.902kg/m

1

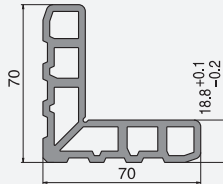
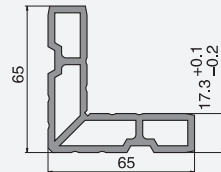
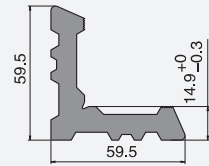
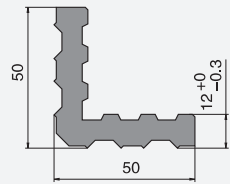

Application	Angle	Application	Angle	Application	Angle	Application	Mullion Connector
DWG No.	GJ6014	DWG No.	JNPK65B119	DWG No.	JNPK55268	DWG No.	JNPK5513
Thickness	δ = 3.0	Thickness	δ = 3.0	Thickness	δ = 3.8	Thickness	—
T.W.	2.702kg/m	T.W.	2.572kg/m	T.W.	2.979kg/m	T.W.	1.231kg/m

2

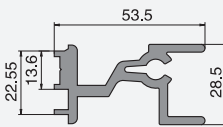
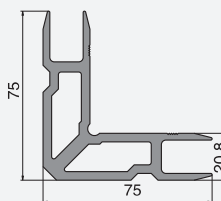
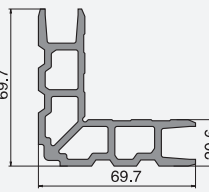
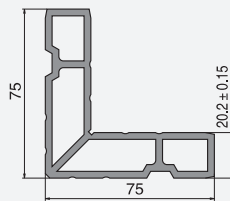

Application	Mullion Connector	Application	Mullion Connector	Application	Mullion Connector	Application	Mullion Connector
DWG No.	JNPK5520	DWG No.	JN60C92	DWG No.	JNPK55180	DWG No.	020899
Thickness	—	Thickness	—	Thickness	—	Thickness	δ = 3.0
T.W.	1.436g/m	T.W.	1.169kg/m	T.W.	0.820kg/m	T.W.	0.618kg/m

3

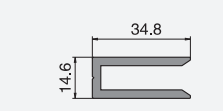
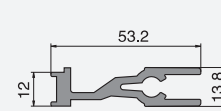
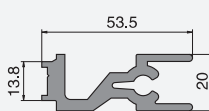
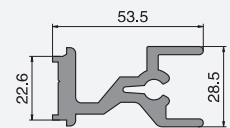

Application	Connector	Application	Box section	Application	90° Corner Post	Application	90° Corner Post
DWG No.	JN60C74	DWG No.	GRPK55076C	DWG No.	RPK55401C	DWG No.	GRPK55053C
Thickness	δ = 1.2	Thickness	δ = 1.4	Thickness	δ = 1.4	Thickness	δ = 1.4
T.W.	0.060kg/m	T.W.	0.901kg/m	T.W.	1.352kg/m	T.W.	1.501kg/m

4

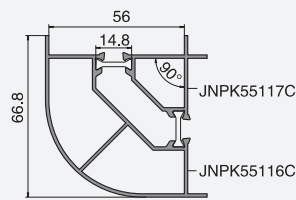
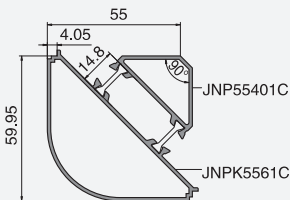
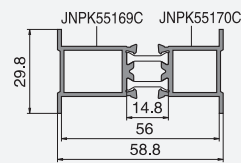
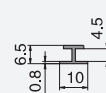

Application	90° Corner Post	Application	90° Corner Post	Application	135° Corner Post	Application	168° Corner Post
DWG No.	GRPK55075C	DWG No.	GRPK55051C	DWG No.	GRPK55069D	DWG No.	GRPK55114C
Thickness	δ = 1.4	Thickness	δ = 1.4	Thickness	δ = 1.5	Thickness	δ = 1.4
T.W.	1.412kg/m	T.W.	1.605kg/m	T.W.	1.214kg/m	T.W.	0.953kg/m

1

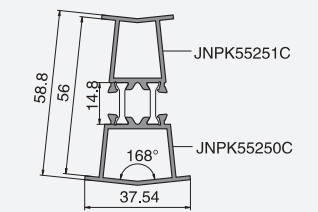
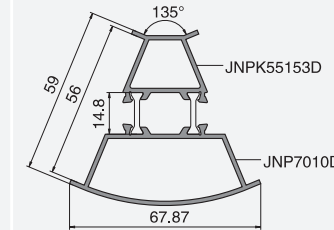
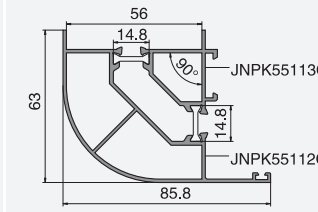
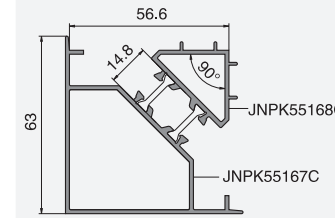

Application	Flash Bar (For Powdercoating)	Application	Flash Bar (For anodizing)	Application	Mosquito Frame	Application	Mosquito Frame
DWG No.	150212	DWG No.	YL-156	DWG No.	HBSC001	DWG No.	HBSC004
Thickness	—	Thickness	—	Thickness	δ = 1.2	Thickness	δ = 1.2
T.W.	0.16kg/m	T.W.	0.174kg/m	T.W.	0.467kg/m	T.W.	0.541kg/m

2

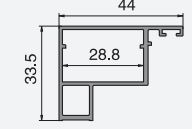
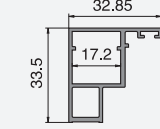
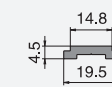
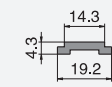

Application	Hinge	Application	—	Application	Mosquito Sash	Application	Screens
DWG No.	HBSC003	DWG No.	HBSC005	DWG No.	HBSC002	DWG No.	JNPK55223
Thickness	—	Thickness	δ = 2.0	Thickness	δ = 1.2	Thickness	δ = 1.2
T.W.	0.230kg/m	T.W.	0.326kg/m	T.W.	0.315kg/m	T.W.	0.393kg/m

3

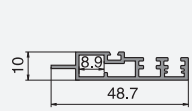
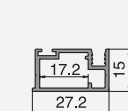
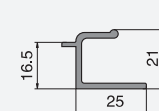
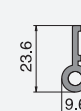

Application	Angle	Application	Angle	Application	Angle
DWG No.	JNYT6029	DWG No.	JN50E019	DWG No.	MX298
Thickness	—	Thickness	δ = 2.5	Thickness	δ = 3.5
T.W.	1.662kg/m	T.W.	1.645kg/m	T.W.	4.817kg/m

4

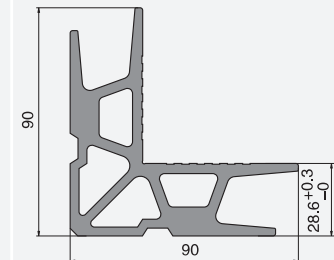
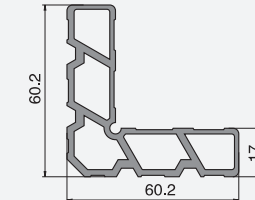
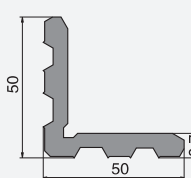



GUANG YA

GRPK55 System Thermal Break in-opening Casement Window (with outer Louver)



GUANG YA

GRPK55 Sectional Drawings

GRPK55 System Thermal Break in-opening Casement Window (with outer Louver)

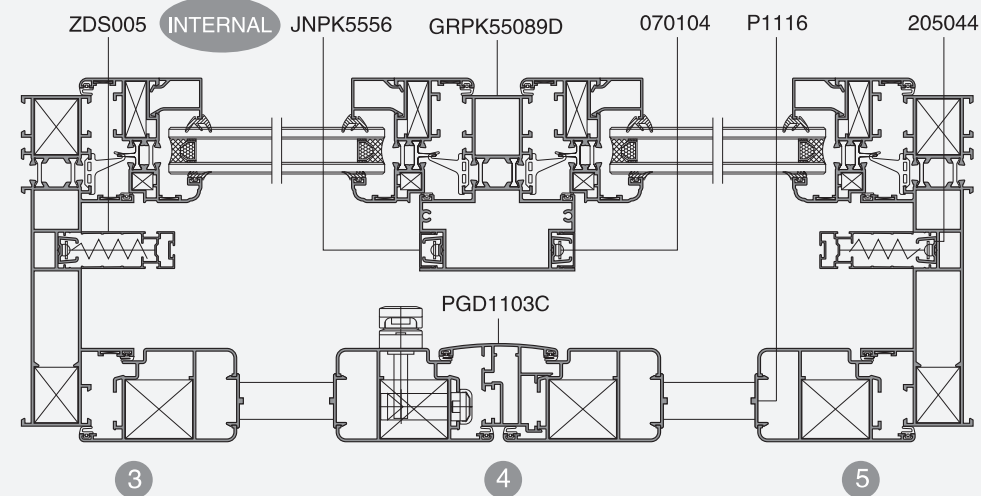
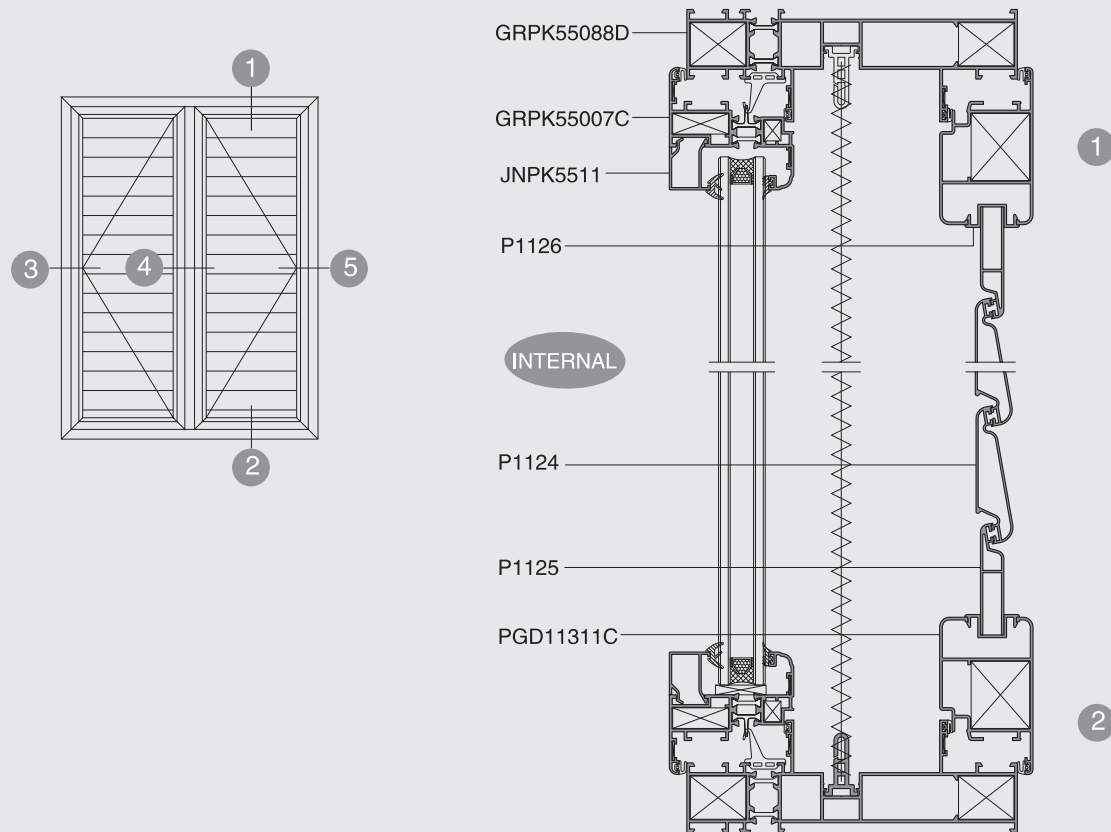

Application	Frame	Application	Mullion	Application	In-opening Sash
DWG No.	GRPK55088D	DWG No.	GRPK55089D	DWG No.	GRPK55007C
Thickness	$\delta = 1.5$	Thickness	$\delta = 1.5$	Thickness	$\delta = 1.4$
T.W.	2.707kg/m	T.W.	2.118kg/m	T.W.	1.226kg/m
Corner joint	YL-9591	Corner joint	JNPK5513	Corner joint	JNPK5579
Cross joint	JNPK5513	Cross joint	JNPK5513	Cross joint	JNPK5579

Application	Sash	Application	Mullion	Application	Bead	Application	Angle
DWG No.	PGD11311C	DWG No.	PGD1103C	DWG No.	JNPK5511	DWG No.	JNPK5579
Thickness	$\delta = 1.4$	Thickness	$\delta = 1.4$	Thickness	$\delta = 1.2$	Thickness	$\delta = 1.2$
T.W.	1.069kg/m	T.W.	0.877kg/m	T.W.	0.264kg/m	T.W.	2.604kg/m
Corner joint	YL-375001	Corner joint	YL-375001	*Mate With GRPK55007C, Glazed for: 30mm			
Cross joint	JNPK55185D	Cross joint	JNPK5551D	Cross joint	JNPK55186D		

Application	Angle	Application	Angle	Application	Mullion Connector	Application	Angle
DWG No.	YL-9591	DWG No.	YL-375001	DWG No.	JNPK5513	DWG No.	P1125
Thickness	$\delta = 5.8$	Thickness	$\delta = 5.8$	Thickness	$\delta = 1.2$	Thickness	$\delta = 1.2$
T.W.	3.117kg/m	T.W.	7.268kg/m	T.W.	1.231kg/m	T.W.	0.448kg/m

Application	Movable Louver	Application	Mounting-slot for Louver	Application	Side cover for Louver	Application	Side cover for Louver
DWG No.	P1124	DWG No.	P1126	DWG No.	P1116	DWG No.	ZDS005
Thickness	$\delta = 1.1$	Thickness	$\delta = 1.4$	Thickness	$\delta = 1.4$	Thickness	$\delta = 0.8$
T.W.	0.540kg/m	T.W.	0.226kg/m	T.W.	0.162kg/m	T.W.	0.341kg/m

Application	Cover	Application	Trunking for Folding Flyscreen	Application	Bead for Folding Flyscreen
DWG No.	JNPK5556	DWG No.	205044	DWG No.	070104
Thickness	$\delta = 0.8$	Thickness	$\delta = 1.2$	Thickness	$\delta = 1.0$
T.W.	0.067kg/m	T.W.	0.113kg/m	T.W.	0.024kg/m



GUANG YA

GRPK55 System Thermal Break in-opening Casement Window (with outer Stainless Steel Flyscreen)



GUANG YA

GRPK55 System Thermal Break out-opening Casement Window (with inner Stainless Steel Flyscreen)

GRPK55 System Thermal Break in-opening Casement Window (with outer Stainless Steel Flyscreen)

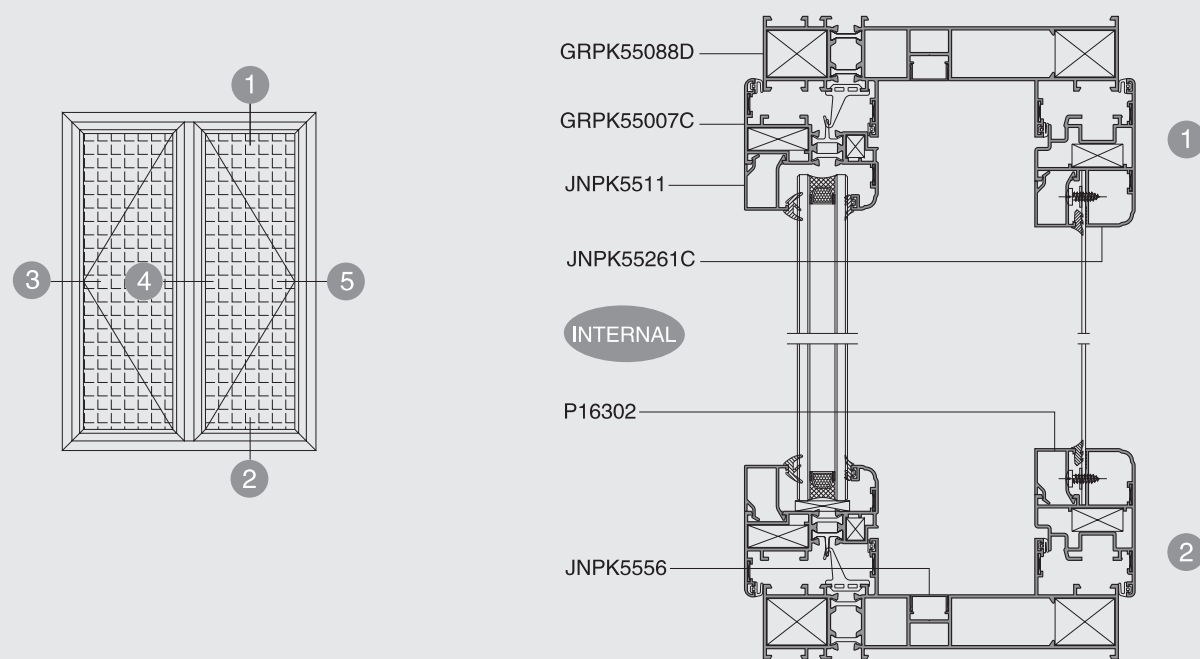

GRPK55 System Thermal Break out-opening Casement Window (with inner Stainless Steel Flyscreen)

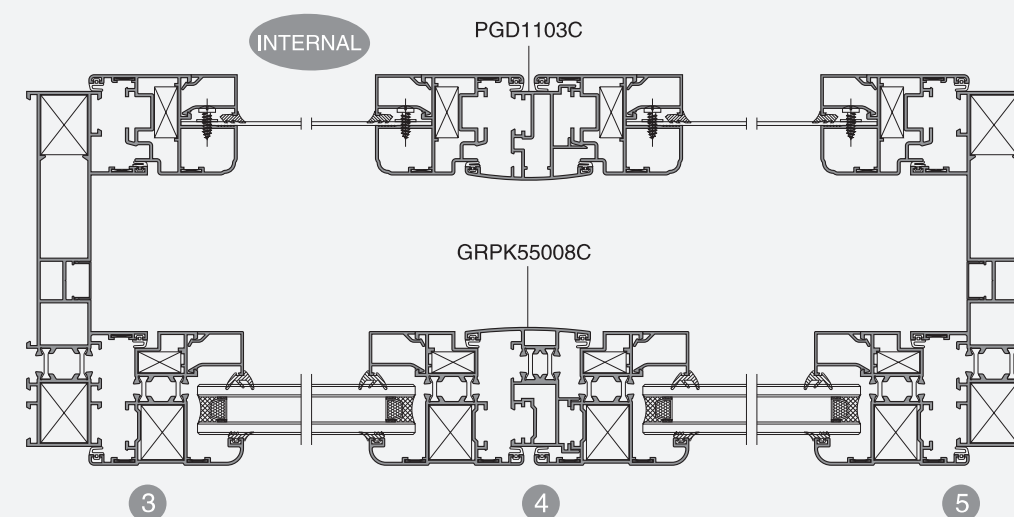
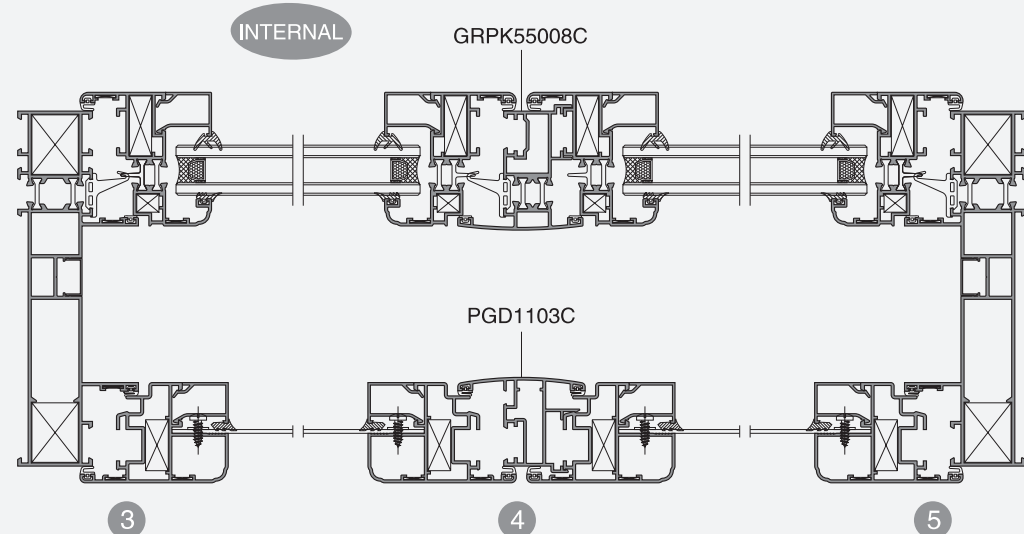
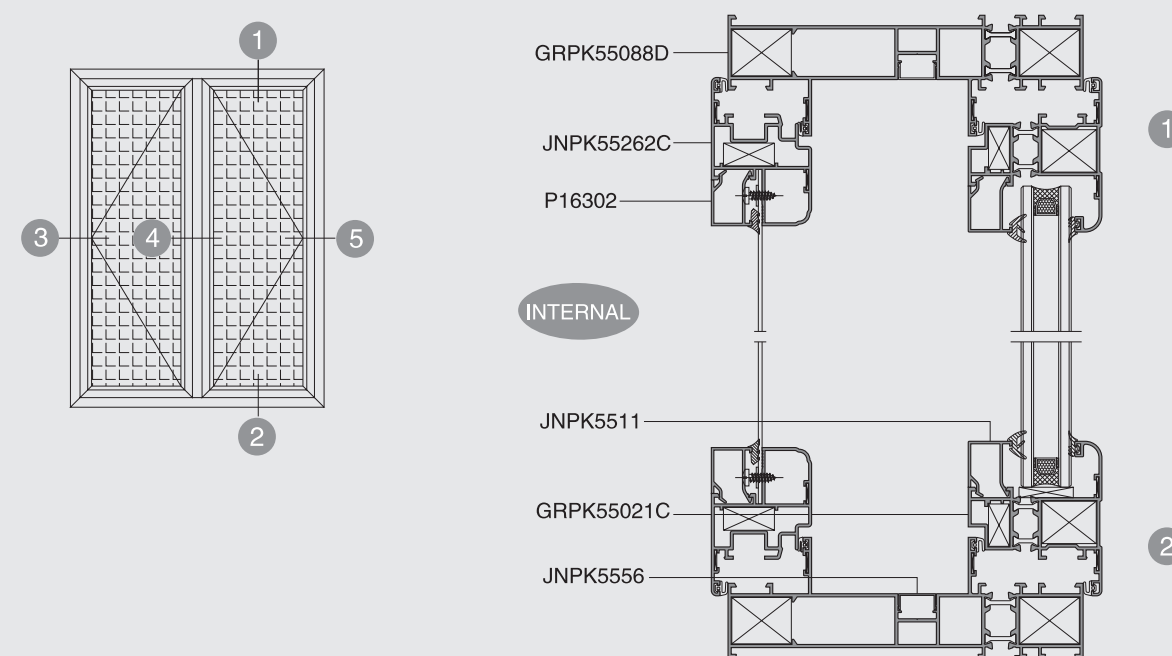



GUANG YA

GRPK55 System Thermal Break in-opening Casement Window (with outer Stainless Steel Flyscreen)

GRPK55 System Thermal Break in-opening Casement Window (with outer Stainless Steel Flyscreen)

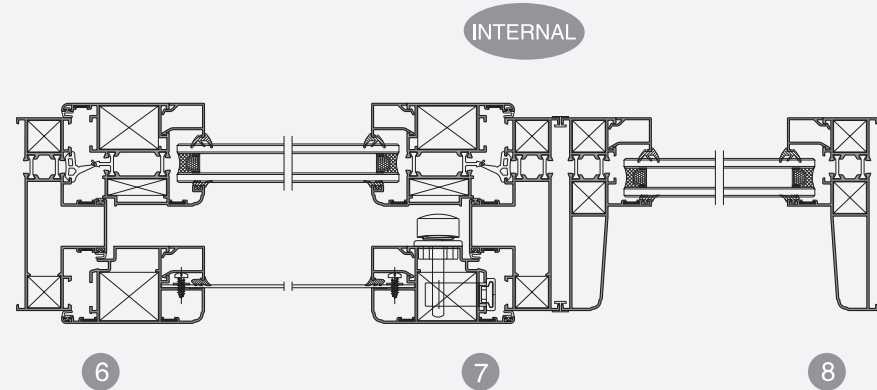
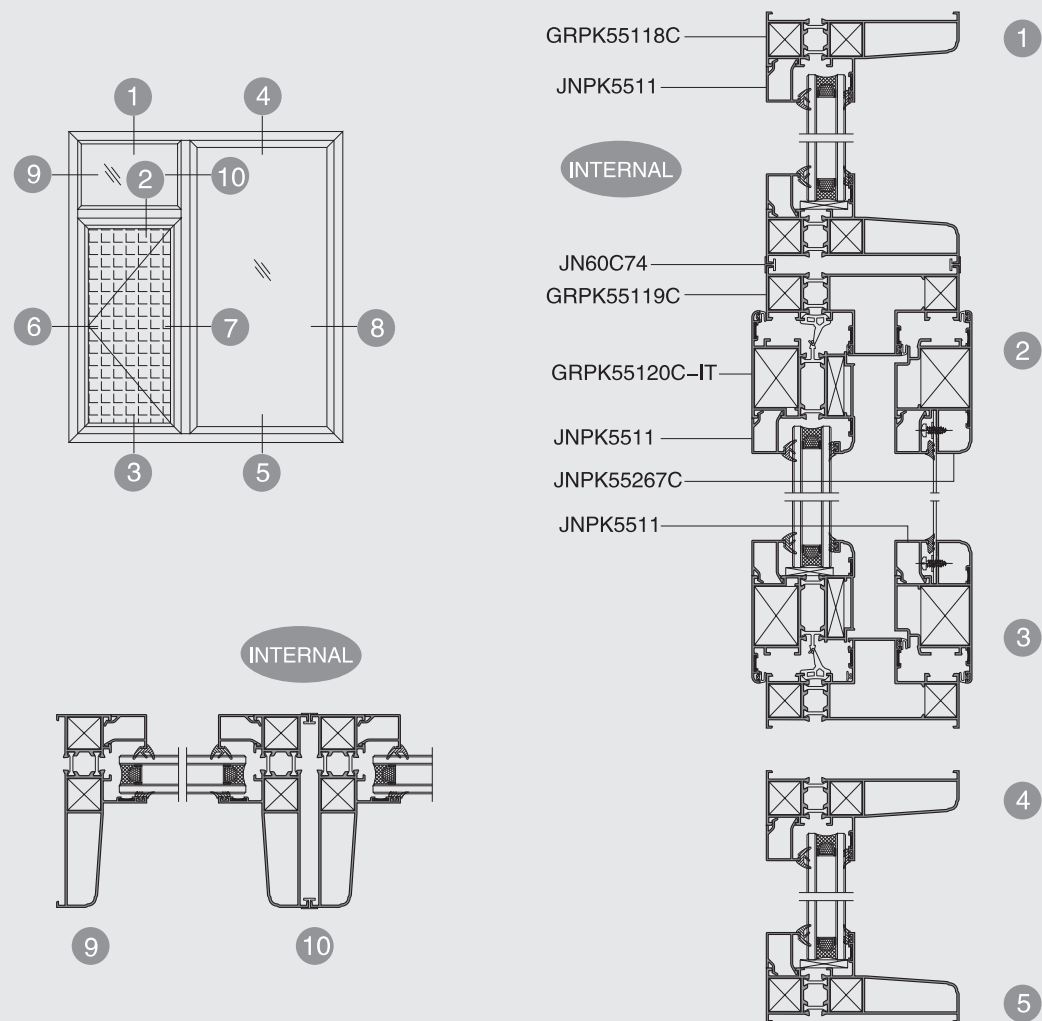

GUANG YA

GRPK55 System Thermal Break out-opening Casement Window (with inner Stainless Steel Flyscreen)

GRPK55 System Thermal Break out-opening Casement Window (with inner Stainless Steel Flyscreen)

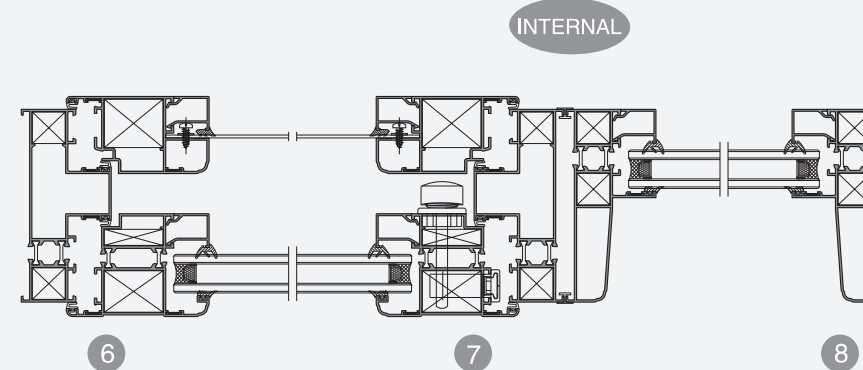
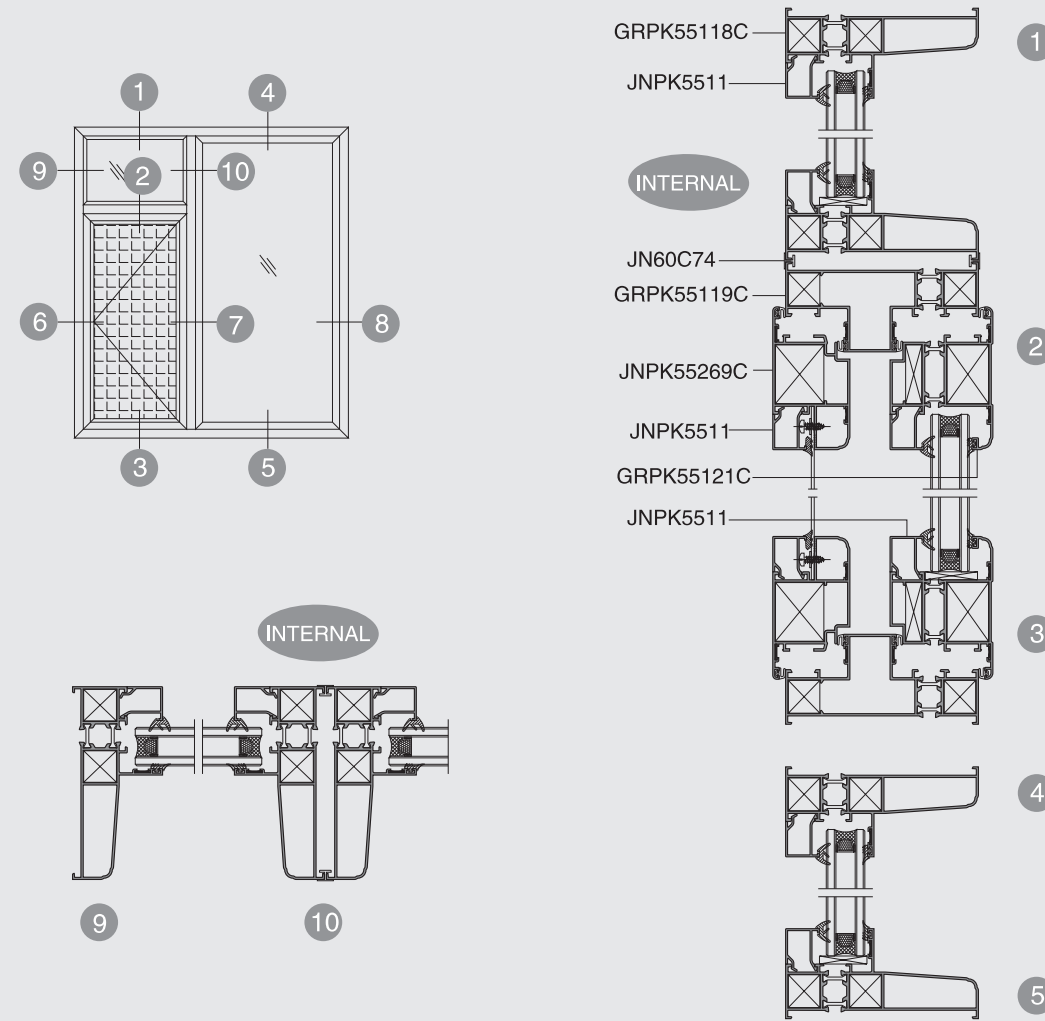



Application	Frame	Application	Frame
DWG No.	GRPK55088D	DWG No.	GRPK55118C
Thickness	$\delta = 1.5$	Thickness	$\delta = 1.4$
T.W.	2.707kg/m	T.W.	1.710kg/m

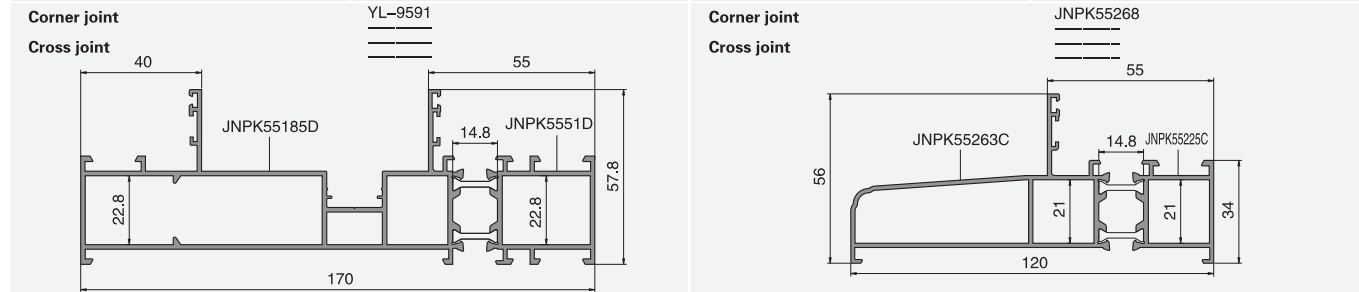

Application	Frame	Application	In-opening Sash	Application	In-opening Sash
DWG No.	GRPK55119C	DWG No.	GRPK55007C	DWG No.	GRPK55120C-IT
Thickness	$\delta = 1.4$	Thickness	$\delta = 1.4$	Thickness	$\delta = 2.0$
T.W.	1.864kg/m	T.W.	1.226kg/m	T.W.	1.687kg/m

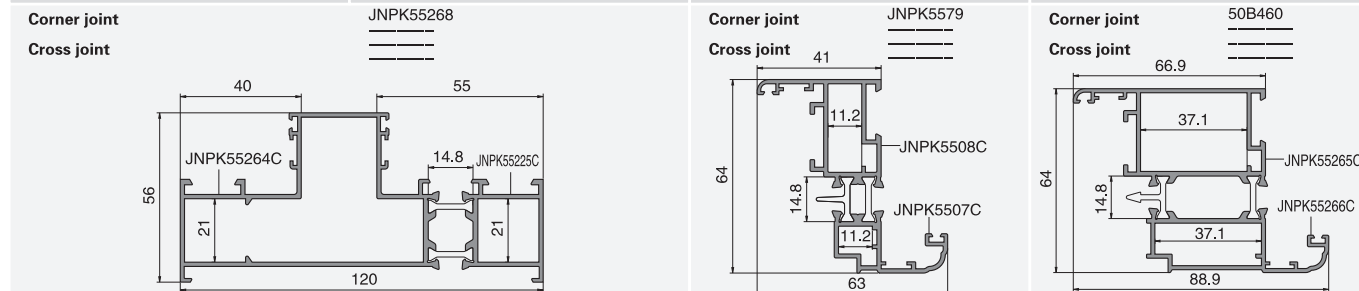

Application	Out-opening Sash	Application	Out-opening Sash	Application	Mullion	Application	In-opening Stainless Steel Flyscreen Sash
DWG No.	GRPK55021C	DWG No.	GRPK55121C	DWG No.	GRPK55008C	DWG No.	JNPK55262C
Thickness	$\delta = 1.4$	Thickness	$\delta = 1.4$	Thickness	$\delta = 1.4$	Thickness	$\delta = 1.4$
T.W.	1.412kg/m	T.W.	1.639kg/m	T.W.	1.291kg/m	T.W.	1.132kg/m

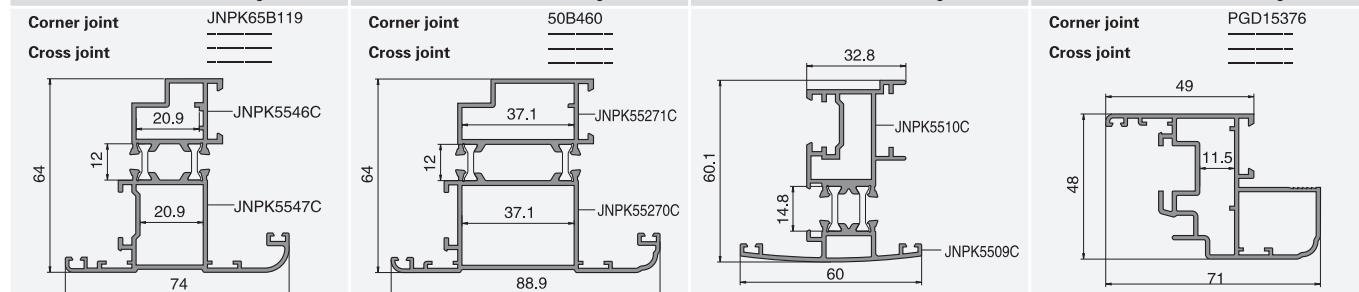

Application	Out-opening Stainless Steel Flyscreen Sash	Application	In-opening Stainless Steel Flyscreen Sash	Application	Out-opening Stainless Steel Flyscreen Sash	Application	Mullion
DWG No.	JNPK55261C	DWG No.	JNPK55269C	DWG No.	JNPK55267C	DWG No.	PGD1103C
Thickness	$\delta = 1.4$	Thickness	$\delta = 1.4$	Thickness	$\delta = 1.4$	Thickness	$\delta = 1.4$
T.W.	1.132kg/m	T.W.	1.202kg/m	T.W.	1.202kg/m	T.W.	0.877kg/m

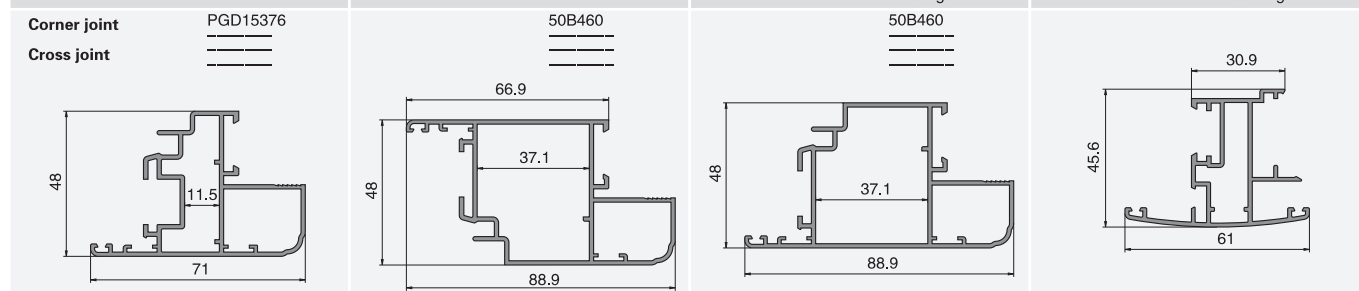

Application	Bead	Application	Bead	Application	Cover	Application	Connector
DWG No.	JNPK5511	DWG No.	P16302	DWG No.	JNPK55556	DWG No.	JN60C74
Thickness	$\delta = 1.2$	Thickness	$\delta = 1.2$	Thickness	$\delta = 0.8$	Thickness	$\delta = 1.2$
T.W.	0.264kg/m	T.W.	0.259kg/m	T.W.	0.067kg/m	T.W.	0.060kg/m

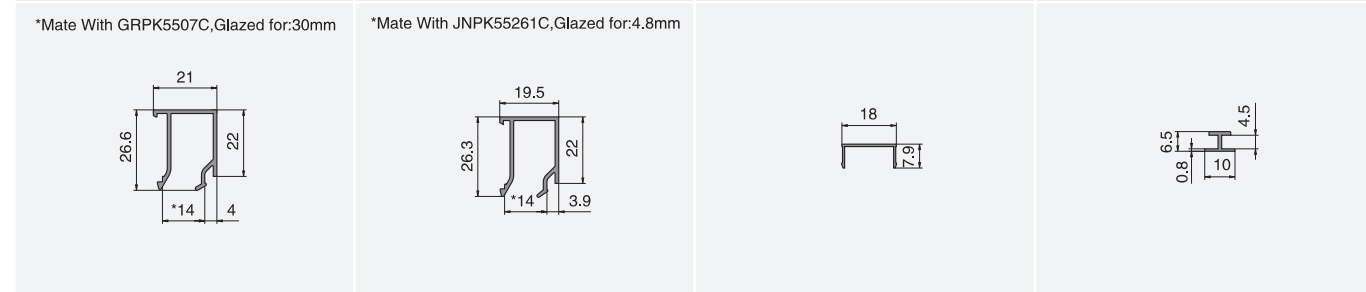

Application	Angle	Application	Angle	Application	Angle	Application	Angle
DWG No.	JNPK5579	DWG No.	PGD15376	DWG No.	JNPK65B119	DWG No.	JNPK55268
Thickness	---	Thickness	$\delta = 2.75$	Thickness	$\delta = 3.0$	Thickness	$\delta = 3.8$
T.W.	2.604kg/m	T.W.	1.367kg/m	T.W.	2.572kg/m	T.W.	2.979kg/m

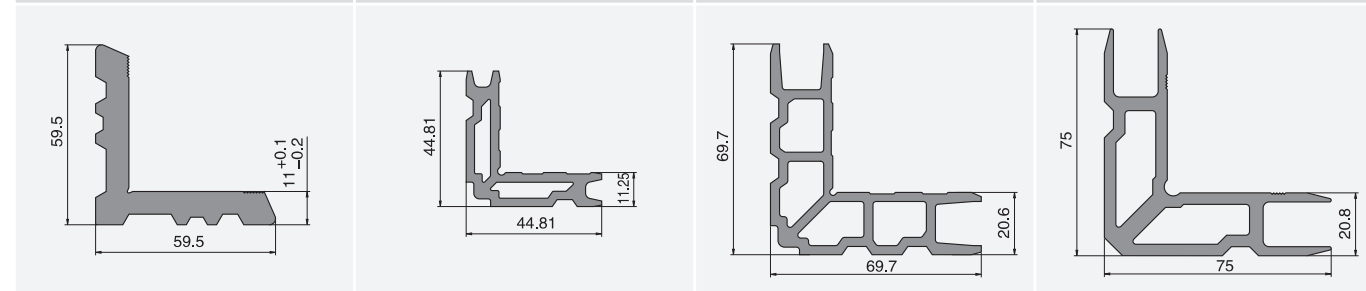

Application	Angle	Application	Angle
DWG No.	YL-9591	DWG No.	50B460
Thickness	---	Thickness	$\delta = 3.0$
T.W.	3.117kg/m	T.W.	3.097kg/m





GUANG YA

GRPK55 System Thermal Break in-opening Casement Door

GRPK55 System Thermal Break in-opening Casement Door

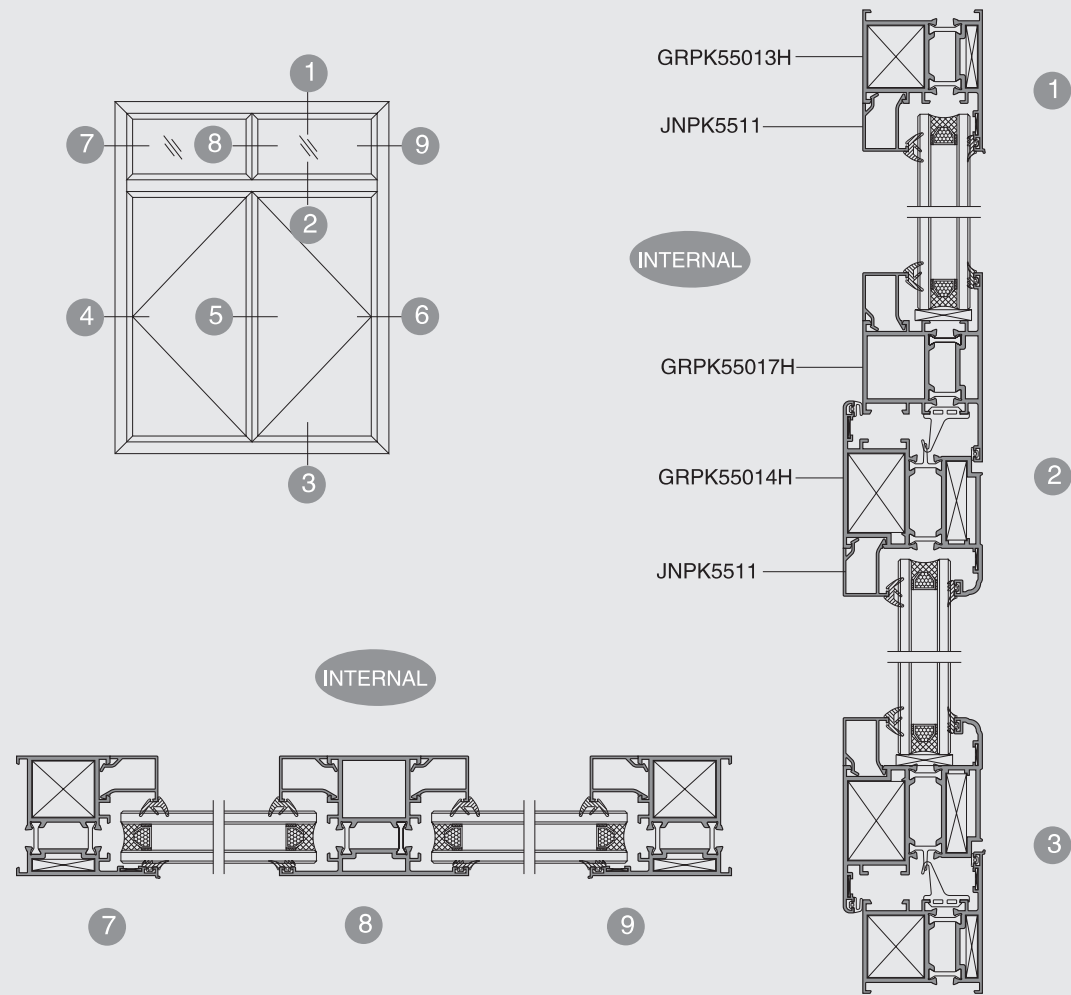

GUANG YA

GRPK55 System Thermal Break out-opening Casement Door

GRPK55 System Thermal Break out-opening Casement Door

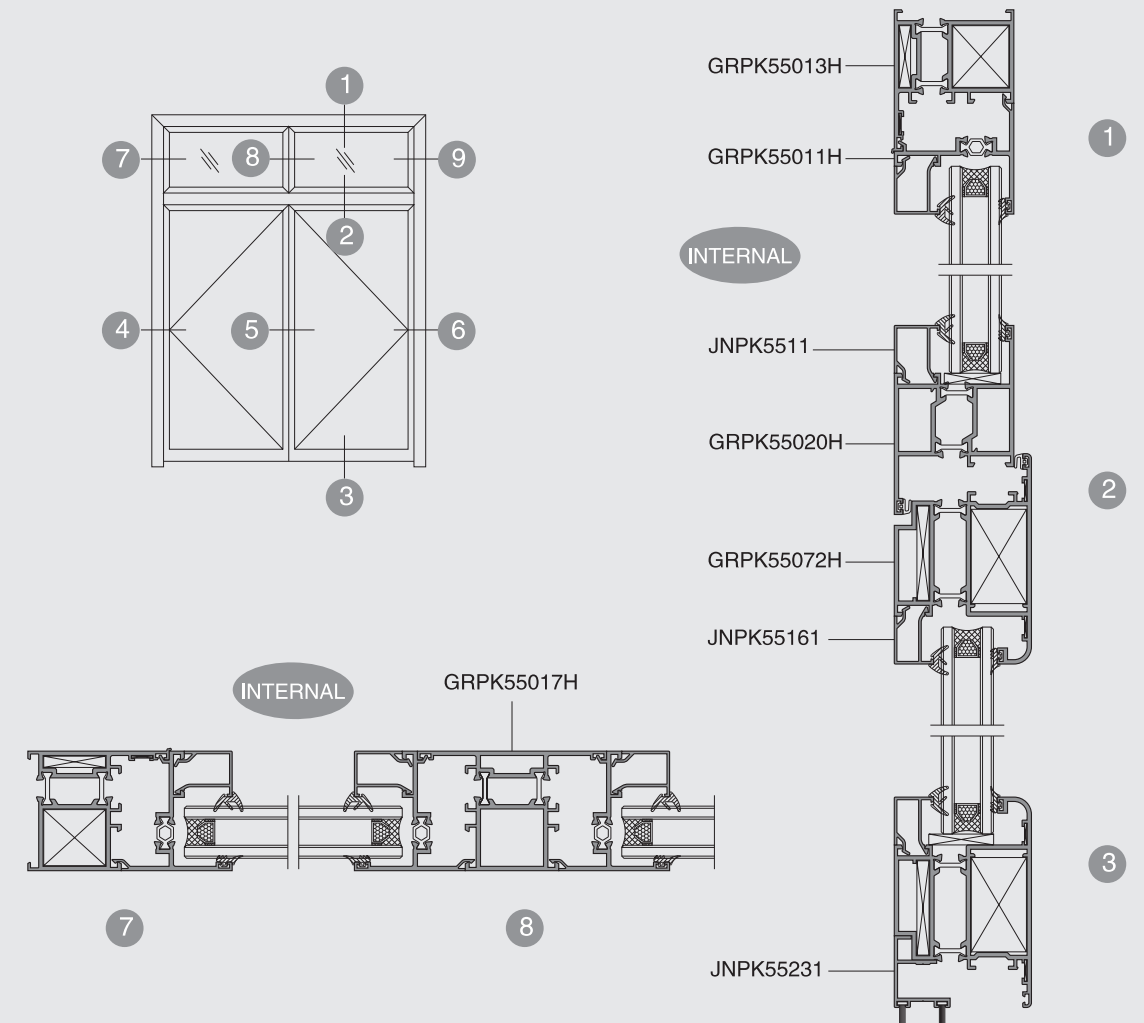



Application	Frame	Application	Frame	Application	Mullion	Application	Mullion
DWG No.	GRPK55013C	DWG No.	GRPK55013H	DWG No.	GRPK55017H	DWG No.	GRPK55020H
Thickness	δ =1.4	Thickness	δ =2.0	Thickness	δ =2.0	Thickness	δ =2.0
T.W.	1.284kg/m	T.W.	1.631kg/m	T.W.	1.821kg/m	T.W.	1.744kg/m
Corner joint	MX298	Corner joint	MX298	Corner joint	=====	Corner joint	=====
Cross joint	=====	Cross joint	JNPK55230	Cross joint	JNPK55230	Cross joint	=====
1							
Application	Connector	Application	In-opening Sash	Application	Out-opening Sash	Application	Out-opening Sash
DWG No.	GRPK55011H	DWG No.	GRPK55014H	DWG No.	GRPK55015H	DWG No.	GRPK55010H
Thickness	δ =2.0	Thickness	δ =2.0	Thickness	δ =2.0	Thickness	δ =2.0
T.W.	0.790kg/m	T.W.	2.118kg/m	T.W.	1.911kg/m	T.W.	2.072kg/m
2							
Application	Out-opening Sash	Application	Transom for in-opening Door	Application	Mullion		
DWG No.	GRPK55072H	DWG No.	GRPK55035H	DWG No.	GRPK55016H		
Thickness	δ =2.0	Thickness	δ =2.0	Thickness	δ =2.0		
T.W.	2.279kg/m	T.W.	2.669kg/m	T.W.	1.496kg/m		
3							
Application	Transom for out-opening Door	Application	Bead	Application	Bead		
DWG No.	GRPK55033H	DWG No.	JNPK5511	DWG No.	JNPK55161		
Thickness	δ =2.0	Thickness	δ =1.2	Thickness	δ =1.2		
T.W.	2.659kg/m	T.W.	0.264kg/m	T.W.	0.254kg/m		
4							

Application	Angle	Application	Angle	Application	Angle	Application	Angle
DWG No.	MX298	DWG No.	YL-5169	DWG No.	YL-9215	DWG No.	JNYT6033
Thickness	δ =3.5	Thickness	-----	Thickness	-----	Thickness	-----
T.W.	4.817kg/m	T.W.	3.602kg/m	T.W.	7.006kg/m	T.W.	5.088kg/m
1							
Application	Angle	Application	Mullion Connector	Application	Sill for Out-opening Sash		
DWG No.	LK5A32	DWG No.	JNPK55230	DWG No.	JNPK55231		
Thickness	δ =3.0	Thickness	-----	Thickness	δ =1.5		
T.W.	3.941kg/m	T.W.	1.243kg/m	T.W.	0.376kg/m		
2							



Application		Application	
DWG No.	AA21001	DWG No.	AA21002
Thickness	$\delta=2.5$	Thickness	$\delta=2.5$
T.W.	3.760kg/m	T.W.	3.607kg/m

1

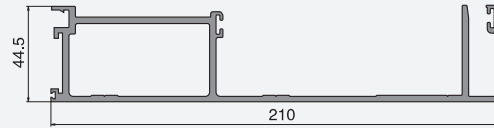
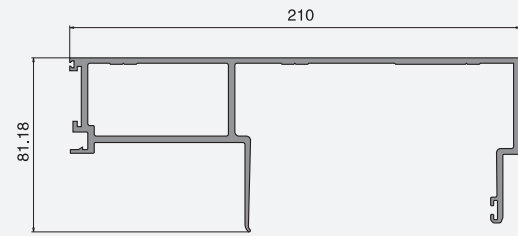

Application		Application		Application		Application	
DWG No.	AA21003	DWG No.	AA21004	DWG No.	AA21005	DWG No.	AA21006
Thickness	$\delta=3.0$	Thickness		Thickness	$\delta=3.0$	Thickness	$\delta=3.0$
T.W.	5.886kg/m	T.W.	4.786kg/m	T.W.	5.745kg/m	T.W.	8.402kg/m

2

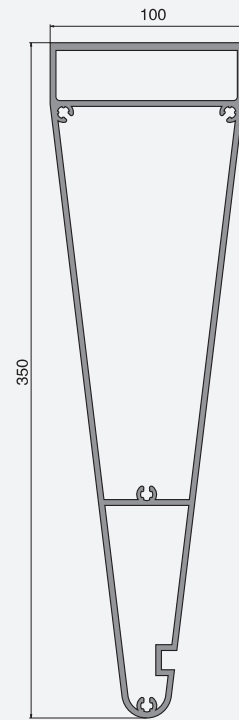
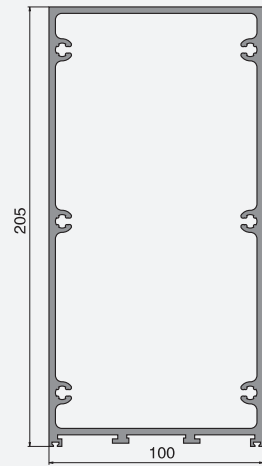
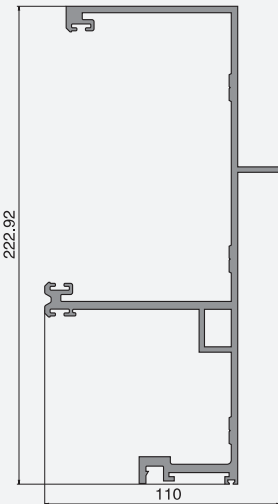
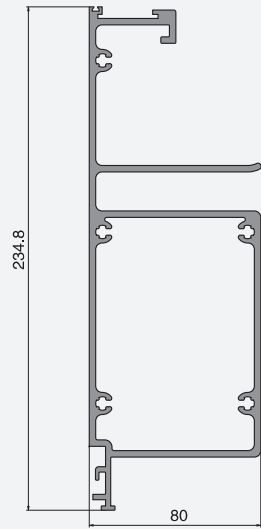

Application		Application		Application		Application	
DWG No.	AA21007	DWG No.	AA21008	DWG No.	AA21010	DWG No.	AA21011
Thickness		Thickness		Thickness	$\delta=2.0$	Thickness	
T.W.	3.244kg/m	T.W.	3.146kg/m	T.W.	0.638kg/m	T.W.	0.363kg/m

3

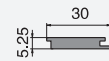
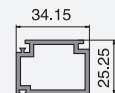
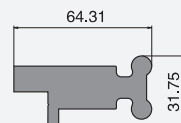
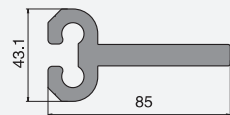

Application		Application		Application		Application	
DWG No.	AA21012	DWG No.	AA21014	DWG No.	AA21017	DWG No.	AA21013
Thickness		Thickness		Thickness	$\delta=1.6$	Thickness	$\delta=2.0$
T.W.	1.299kg/m	T.W.	4.613kg/m	T.W.	0.230kg/m	T.W.	0.454kg/m

1

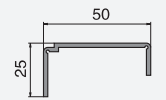
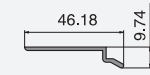
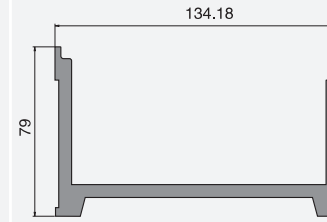
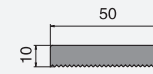

Application		Application		Application		Application	
DWG No.	AA21015	DWG No.	AA21016	DWG No.	AA21018		
Thickness		Thickness	$\delta=2.5$	Thickness			
T.W.	0.654kg/m	T.W.	0.781kg/m	T.W.	0.305kg/m		

2

